

Securit®

SAY IT WITH
QUALITY

MACCHIATO	2.00	2.50
LATTE	2.50	
MOCHA	3.00	
COLD BREW	3.25	2.50
HOT TEA	2.50	4.00
	2.25	3.50
HOT CHOCOLATE		
	8oz	12oz
	2.50	3.50
		16oz
		4.50
HOUSE SYRUP		
	vanilla / caramel / peppermint	
BEVERAGES		
ORANGE JUICE		
LEMON DE		
ICED TEA		
SMOOTHIES		
strawberry / apple		
ITALIAN SODA		
MINERAL WATER		
sparkling		
SWEET & PASTRY		
FRESH BAKED DAILY		



60 NEW
PRODUCTS



Securit®



www.securit.nl

Vermes bv | Katernstraat 1 | 1321 NC Almere | The Netherlands
+31 (0)36 531 3554 | info@vermes.nl



Contents



11



22



104



56



137



118

64

8. PAVEMENT CHALKBOARDS

FR panneaux trottoir DE gehwegtafeln IT lavagne da strada ES caballetes pizarras para exterior PT quadros de exterior CZ nabídkové tabule

20. TABLE CHALKBOARDS

FR ardoises de table DE tisch kreidetafeln IT lavagne da tavola ES pizarras de sobremesa PT quadros de mesa CZ stolní popisovací tabule

42. WALL CHALKBOARDS

FR ardoises murales DE wand kreidetafeln IT lavagne da parete ES pizarras de pared PT quadros de parede CZ nástěnné popisovací tabule

58. CHALKBOARD PAINT

FR peinture ardoise DE kreidetafelfarbe IT pittura lavagna ES pintura de pizarra PT tinta para quadros CZ barva pod křídlové popisovače

60. SELF ADHESIVE CHALKBOARDS

FR ardoises auto-adhésives DE selbstklebende kreidetafel IT lavagne autoadesive ES pizarras autoadhesivas PT quadros adesivos CZ nalepovací popisovací tabule

64. CHALKMARKERS

FR feutres-craie DE kreidemarker IT pennarelli a gesso liquido ES rotulador de tiza líquida PT marcadores de giz líquido CZ křídlové popisovače

78. MENU HOLDERS

FR protège-menus DE menükarten IT portamenù ES porta-cartas PT porta menù CZ jídelní listky

102. POSTER FRAMES

FR porte-affiches DE plakatisdisplays IT porta poster ES porta carteles PT molduras para pósters CZ plakátové rámy

109. LED SIGNS

110. INFORMATION DISPLAYS

FR panneaux d'affichage DE informationsdisplay IT espositori informativi ES expositores DE información PT ecrãs de informação CZ informační tabule

129. BARRIER SYSTEMS

FR poteaux d'accueil DE absperssysteme IT colonne segnapercorso ES postes de acogida PT postes separadores CZ zábránové systémy

136. SMOKERS POLE

FR cendriers DE standascher IT posaceneri ES ceniceros PT cinzeiros CZ popelníky

137. STORE DISPLAYS

142. ICONS

144. INDEX

New PRODUCTS '17

We proudly present to you our 2017 catalogue. This year, even more so than others, we hope to surprise you with over 60 new products. The creation of these novelties have taken place whilst studying the latest market trends. However, we do not wish to follow where the existing path may lead. Our passion is to be pioneers in creating new paths and leave a trail for all those using and enjoying Securit products. Quality, innovation and practicality are the cornerstones of our work. Enjoy our new catalogue!

Michael Vermes, CEO

FR C'est avec fierté que nous vous présentons notre catalogue 2017. Cette année, bien plus que celles passées, nous espérons vous surprendre avec plus de 60 nouveaux produits. La création de ces nouveautés a été possible grâce à l'étude des dernières tendances sur le marché. Cependant, nous ne souhaitons pas suivre le même chemin, notre passion étant de rester pionnier dans la création de nouveau trajet et de laisser nos traces pour tous ceux qui utilisent et apprécient nos produits Securit. Qualité, innovation et fonctionnalité pratique sont les pierres angulaires de notre travail. Profitez pleinement de notre nouveau catalogue!

DE Wir präsentieren stolz den Katalog von 2017. Dieses Jahr überraschen wir Sie mit mehr als 50 neuen Produkten. Die Inspirationen für unsere neuen Produkte entstanden durch das Beobachten der neusten Marktentwicklungen. Allerdings möchten wir bestehenden Wegen nicht folgen, denn unsere Leidenschaft besteht darin, neue Wege zu ergründen. Somit möchten wir all denen, die Securit® Produkte benutzen, einen Leitfaden mit an die Hand geben. Qualität, Innovation und Machbarkeit sind die Grundsteine unserer Arbeit. Viel Spaß bei unserem neuen Katalog 2017 wünscht Ihnen!

IT Siamo orgogliosi di presentarvi le novità 2017. Dietro ogni prodotto si nasconde un

team appassionato e creativo che cerca di pensare fuori dagli schemi per soddisfare le vostre necessità. Quest'anno abbiamo cercato di sorprendervi con una vasta gamma di nuovi prodotti. La nascita dei nuovi articoli avviene dopo uno studio delle ultime tendenze di mercato; sia ben chiaro, noi non vogliamo seguirle vogliamo essere i pionieri nel creare sempre di nuove. Cerchiamo di migliorare l'oggi con uno sguardo al domani. La qualità, l'innovazione e la praticità sono i capisaldi del nostro lavoro. Godetevi il nostro nuovo catalogo 2017!

ES Estamos orgullosos de presentar las novedades 2017. Detrás de cada producto se encuentra un equipo apasionado y creativo que trata de pensar fuera de la caja para satisfacer sus necesidades. Este año hemos tratado de sorprenderles con una amplia gama de nuevos productos. La creación de nuevos artículos se lleva a cabo después del estudio de las últimas tendencias del mercado, tenga en cuenta que no queremos seguirlos, sino ser Pioneros en la creación de nuevas ideas y soluciones para el sector. Tratamos de mejorar el hoy con una mirada al futuro. Calidad, innovación y practicidad son los pilares de nuestro trabajo. Disfruten de nuestro nuevo catálogo 2017!

PT Estamos orgulhosos de vos apresentar as novidades para o ano 2017. Por trás de cada artigo, existe uma equipa

apaixonada e criativa, que tenta pensar fora dos parâmetros do convencional, para satisfazer as vossas necessidades. Este ano, procurámos surpreender-vos com uma vasta gama de novos produtos. Os novos produtos foram criados após a análise das últimas tendências de mercado; que fique bem claro, nós não queremos simplesmente segui-las, nós queremos ser pioneiros na criação de novas tendências. Procurámos melhorar o presente, sempre com o olhar no futuro. Qualidade, inovação e praticidade são os baluartes do nosso trabalho. Desfrutem do vosso novo catálogo 2017!

CZ S hrdostí představujeme naše nové produkty pro rok 2017. Pokaždé věnujeme velkou péči vývoji nového sortimentu, ale tento rok jsme naši nabídku opravdu podstatně rozšířili. Stále sledujeme vývojové trendy na trhu, což ukazuje nová řada jídelních lístků, polička na vytváření nápísů nebo třeba šestiúhelníkové tabulky. Tyto produkty budou ladit s interiéry a zároveň vynikát svým osobitým designem. Kromě toho, že naše novinky jsou moderní, snažíme se stále i o nápaditost. Například nové jídelní lístky a desky na účtenku řady Caddy jsou nejen atraktivní, ale i velice praktické. Užijte si procházení našim katalogem pro rok 2017!



TABLE BOARD | P.39



TABLE CADDY | P.32



LETTER SHELF | P.56



LEATHER RANGE, ROYAL BLACK | P.81



BILL PRESENTER | P.83



BOTTLE TAG | P.35



HEXAGON CHALK- AND CORKBOARDS | P.54

EZL-TE-165
P.18

Navement

Chalkboards

Danneaux trottoir

GEHWEGTAFELN

Lavagne da strada

CABALLETES PIZARRAS

PARA EXTERIOR

*Quadros
de exterior*

NABÍDKOVÉ
TABULE

SBS-TE-120
P.11

SBD-TE-85
P.11



SEAFOOD
RESTAURANT
BEST IN TOWN
Fresh Always



Deluxe



EN Deluxe Pavement Chalkboards - Heavy duty hard rubberwood frame coated with layers of quality weather-protection lacquer, reinforced joints and writing surface completed with industrial stainless steel components.

FR Panneaux Trottoir Deluxe - Ils sont pratiques et très résistants aux intempéries. Grâce à leur cadre en bois dur recouvert d'un vernis de protection, de joints renforcés, d'une large surface d'écriture et de composants en acier inoxydable.

DE Gehwegtafel "Deluxe" - Aus Hartgummi-Holz, beschichtet mit hochwertigem, witterungsbeständigem Schutzlack und verstärkten Gelenken. Die beiden Seiten werden mit Komponenten aus Edelstahl befestigt. **IT** Lavagne da Strada

Deluxe - Legno duro esotico rivestito con strati di lacca protettiva per agenti atmosferici. La superficie di scrittura e gli angoli sono rafforzati con parti in acciaio inox. **ES** Caballetes Pizarras para Exterior Deluxe - Estructura de madera exótica dura de alto rendimiento recubierta con capas de laca de calidad de protección contra la intemperie. La superficie de escritura y las juntas están reforzadas con componentes de acero inoxidable industrial. **PT** Quadros de Pavimento Deluxe - Moldura em Madeira Exótica endurecida e lacada com camadas de proteção contra o clima, articulações reforçadas e superfície de escrita com acabamentos e componentes em aço inox. **CZ** Nabídkové Tabule Deluxe - Mají rámy z masivního tvrdého gumovníkového dřeva s lakem odolným povětrnostním podmínkám, masivní kování z nerezové oceli a odolnou popisovací plochu.

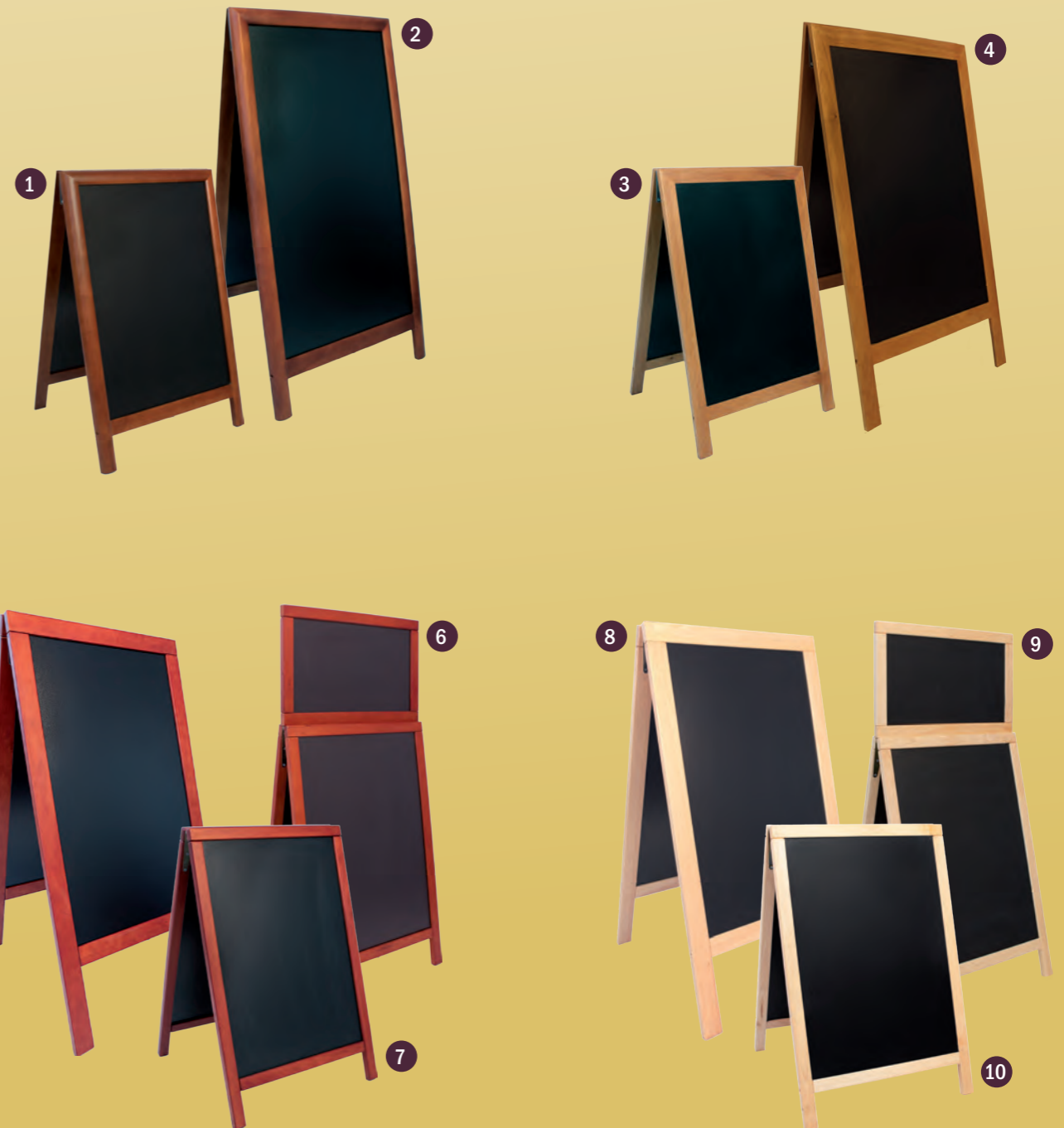

- 1 SBD-DB-85 | 89x58x7cm | 8,35kg 2 SBS-DB-120 | 130x71,5x7,5cm | 16,8kg 3 SBD-TE-85 | 88x57x6cm | 8,25kg
 4 SBS-TE-120 | 130x73x7,5cm | 15,35kg 5 SBS-M-135 | 143x74,5x7cm | 17,9kg 6 SDT-M-120 | 87x56,5x6,5cm | 11,2kg
 7 SBD-M-85 | 89x57,5x6,5cm | 8,75kg 8 SBS-B-135 | 143x74,5x7cm | 17,9kg 9 SDT-B-120 | 87x56,5x6,5cm | 11,2kg
 10 SBD-B-85 | 89x57,5x6,5cm | 8,75kg



Woody

EN Woody Pavement Chalkboards - Robust pine wood, coated with layers of quality weather-protection lacquer. Reinforced joints and writing surface, completed with industrial stainless steel components.

FR Panneaux Trottoir Woody - Ils sont pratiques et résistants aux intempéries. Grâce à leur cadre en pin recouvert d'un vernis de protection, de joints renforcés, d'une large surface d'écriture et de composants en acier inoxydable.

DE Gehwegtafel "Woody" - Aus Kiefernholz, beschichtet mit hochwertigem, witterungsbeständigem Schutzlack und verstärkten Gelenken. Die beiden Seiten werden mit Komponenten aus Edelstahl befestigt. **IT** Lavagne da Strada Woody - Resistente legno di pino rivestito con strati di lacca protettiva per agenti atmosferici. La superficie di scrittura e gli angoli sono rafforzati con parti in acciaio inox. **ES** Caballetes Pizarras para Exterior Woody - Robusta madera de pino cubierta con capas de laca de protección contra la intemperie. La superficie de escritura y las juntas están reforzadas con componentes de acero inoxidable industrial. **PT** Quadros de Pavimento Woody - Madeira de Pinheiro robusta lacada e revestida de proteção contra o clima, articulações reforçadas e superfície de escrita com componentes de aço inox.

CZ Nabídkové Tabule Woody - Mají rámy z masivního borového dřeva s lakem odolným povětrnostním podmínkám, masivní kování z nerezové oceli a odolnou popisovací plochu.



1 SBSW-M-120 | 129,5x71,5x7cm | 9,65kg 2 SBS-BL-120 | 129,5x71,5x7cm | 9,65kg 3 SBD-BL-85 | 89,5x56,5x6,5cm | 5,65kg
4 SBDW-TE-85 | 89x56,5x6,5cm | 5,35kg 5 SBSW-TE-120 | 129,5x71,5x7cm | 9,65kg



- 1 SBM-BL-115 | 119x67x3cm | 4,6kg 2 SBM-SS-115 | 119x67x3cm | 4,6kg
3 SBM-WT-115 | 119x67x3cm | 4,6kg 4 SBM-FEET | 41x16x4,5cm | 1,52kg

Multi boards

EN Multiboard Pavement Chalkboards - Connect and multiply chalkboards to create any layout. This space saving chalkboard provides privacy while reducing noise and wind. Divide areas whilst providing the ideal crowd control and chalk signage solution.

FR Multi-ardoises - Connectez plusieurs ardoises et créez vous-même la disposition que vous souhaitez. Sur une terrasse, vous pourrez délimiter des espaces tout en faisant passer votre message. C'est un moyen de communication pratique et ludique. **DE** Multi-Kreidetafeln - Verbinden und erweitern Sie so viele Tafeln wie Sie möchten. Eine platzsparende Kreidetafel, die Privatsphäre, Lärm und Wind Reduktion bietet. Teilen Sie Bereiche ab und gewährleisten Sie gleichzeitig die optimale Kontrolle von Menschenmengen und Kreide Signage-Lösung. **IT** Lavagne Multiboard - Collega tra di loro più lavagne per realizzare il layout desiderato. Una lavagna multiuso e salvaspazio che aumenterà la privacy dei clienti proteggendoli inoltre da vento e rumori. Potrete utilizzarle come un separè/lavagna che vi permetterà di comunicare e limitare spazi. **ES** Multi-pizarras para Aceras - Conecta y multiplica pizarras para crear cualquier disposición. Una pizarra que ahorra espacio, proporciona privacidad, reducción de ruido y viento. Pueden ser utilizadas como paneles divisorios/pizarras que permitirá comunicarse y limitar espacios. **PT** Quadros de Pavimento com Várias Tábuas - Junte e multiplique quadros para criar qualquer disposição. Um quadro que poupa espaço e que fornece privacidade, e redução de vento e barulho. Divida áreas ao fornecer a solução ideal de controlo do público e uma solução de sinalização de giz. **CZ** Nabídkové Tabule Multiboard - Jsou spojovatelné s možností vytvoření velké popisovací plochy. Umožní oddělení prostoru chráněného před hlukem a větrem. Jsou vhodné i pro rozdělení prostoru s pohybem velkého množství lidí.





welcome
to our
CAFE

SBS-M-135
P.11

Securit[®]

SUITS
our
BUSINESS

 @SECURIT.NL    #SECURIT_NL

Easel

EN Chalkboard Easel - Hard lacquered rubberwood with three adjustable display options. Suitable for boards wider than 50cm.

FR Chevalets - Support en bois dur vernis et ajustable en 3 hauteurs différentes. Convient pour les ardoises de plus de 50cm de largeur. **DE** Kreidetafelstaffelei - Aus Hartgummi-Holz beschichtet. Mit hochwertigem, witterungsbeständigem Schutzlack. Mit drei verschiedenen, möglichen Einstellungen für verschiedene Kreidetafelgrößen. **IT** Cavalletto per Lavagne - Realizzato in un legno duro esotico con 3 opzioni di utilizzo regolabili. Adatto per lavagne con una larghezza superiore a 50cm. **ES** Caballete para Pizarra - Madera exótica dura lacada con tres opciones de exposición ajustables diferente. Adecuada para pizarras con un ancho mayor de 50cm. **PT** Cavalete para Quadros - Madeira Exótica endurecida e revestida com três opções ajustáveis de exibição. Adequada para quadros com uma largura de mais de 50cm. **CZ** Stojany Easel - Vyrobeny z tvrdého gumovníkového dřeva se 3 pozicemi pro umístění popisovací tabule (s min. šířkou 50cm).



1 - 2 - 3
 1 **EZL-B-165** | 166x11x5cm | 3,4kg 2 **EZL-M-165** | 166x11x5cm | 3,4kg 3 **EZL-BL-165** | 166x11x5cm | 3,4kg
 4 **EZL-TE-165** | 166x11x5cm | 3,4kg 5 **EZL-DB-165** | 166x11x5cm | 3,4kg



LED lamp

EN LED Lamp - Illuminate our pavement chalkboards and/or information displays to brighten your messages.

FR Lampe LED- Eclairage pour Tableau Ardoise, chevalet Trottoir ou tout autre présentoir pour illuminer vos messages. **DE** LED Lampe - beleuchtet unsere Kundenstopper und/oder Informationstafeln um Ihre Informationen ins rechte Licht zu rücken. **IT** Lampada a Led con attacco a clip- Per illuminare lavagne, leggii ed espositori di notte affinché il menu sia sempre visibile. **ES** Lámpara de LEDs con pinza - Para iluminar pizarras, atriles y expositores de noche, así el menú será siempre visible. **PT** Lâmpada de LED com clip - Para iluminar cavaletes de rua e / ou expositores de menu exteriores. **CZ** Lampa LED - osvětlují nabídkové tabule pro zdůraznění nápisu.



1 - 2 - 3
 1 **LP-BL-2** | 31x7,5x11cm | 1kg 2 **LP-BL-1** | 31x7,5x11cm | 0,5kg
 1 - 24
 3 **MCS-BATT** | 16,5x7,5x1cm | 0,4kg

CAD-TE
P.33

Table Chalkboards

Ardoises de table

TISCH TAFELN

Lavagne da tavola

PIZARRAS DE SOBREMESA

Quadros de mesa

STOLNI POPISOVACI

TABULE



Silhouette wood/mini

1

NEW

EN Wood Table Chalkboards - Precision cut shapes from a strong, yet flexible, double sided writing surface, with a hard wooden base.

FR Ardoise de Table avec Base en Bois - Surface d'écriture double face flexible, aux formes originales et socle en bois. **DE** Tisch-Kreidetafel mit Holzsockel - Erhältlich in verschiedenen Formen. **IT** Lavagne con Base in Legno - Le forme sono realizzate con precisione su una superficie di scrittura flessibile ed utilizzabile da entrambi i lati.

ES Pizarras de Madera para Mesa - Formas recortadas con precisión en una superficie de escritura de doble cara, fuerte pero flexible, con una base de madera dura.

PT Quadros de Mesa em Madeira - Formas cortadas com precisão numa superfície de escrita forte, mas flexível de dois lados com uma base de madeira. **CZ** Stolní Tabule Wood - Mají nápadité tvary, jsou oboustranné, z pružného materiálu, s podstavcem z tvrdého masivního dřeva.



1 6 24

1 **FBT-CARRY** | 32,5x21x6cm | 0,375kg 2 **FBT-PLATE** | 24x25x6cm | 0,283kg 3 **FBT-TEAPOT** | 24x33x6cm | 0,283kg 4 **FBT-CUP** | 22x33x6cm | 0,316kg 5 **FBT-HOUSE** | 33x21x6cm | 0,375kg 6 **FBT-MEMO** | 34,5x21x6cm | 0,283kg 7 **FBT-MIX-3** | 10x12x2cm | 0,166kg 8 **FBT-PLATE-3** | 10x12x2cm | 0,166kg 9 **FBT-TEAPOT-3** | 10x12x2cm | 0,166kg 10 **FBT-CUP-3** | 10x12x2cm | 0,21kg



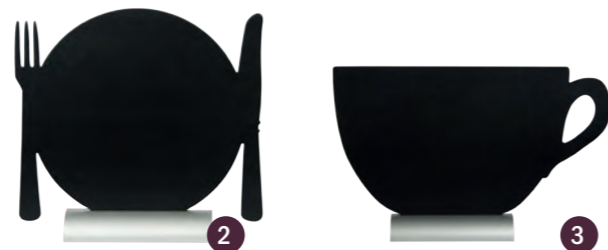

1 2 3 4 5 6

1 FBTA-A4 | 29x21x4cm | 0,433kg 2 FBTA-PLATE | 24x25x4cm | 0,433kg 3 FBTA-CUP | 21x34x4cm | 0,433kg 4 FBTA-ICECREAM | 27x25x4cm | 0,433kg 5 FBTA-CHEF | 35x22x4cm | 0,433kg 6 FBTA-PIZZA | 25x34x4cm | 0,433kg 7 END FBTA-BURGER | 25x27x4cm | 0,433kg 8 END FBTA-SANDWICH | 35x33x4cm | 0,433kg 9 FBTA-MENU | 34x21x4cm | 0,433kg 10 FBTA-WINE | 35x33x4cm | 0,433kg 11 FBTA-CHAMPAIGN | 35x21x4cm | 0,433kg 12 FBTA-COCKTAIL | 35x21x4cm | 0,433kg 13 FBTA-BEER | 24x22x4cm | 0,433kg



Silhouette aluminium

1



EN Aluminium Table Chalkboards - Precision cut shapes from a strong yet flexible, double sided writing surface, with an aluminium base.

FR Ardoises de Table avec Base en Aluminium - Surface d'écriture double-face flexible, aux formes originales et socle en aluminium. **DE** Tisch-Kreidetafel mit Aluminiumsockel - Erhältlich in verschiedenen Formen. **IT** Lavagne con Base in Alluminio - Le forme sono realizzate con precisione su una superficie di scrittura flessibile ed utilizzabile da entrambi i lati **ES** Pizarras de Aluminio de Mesa - Formas recortadas con precisión en una superficie de escritura de doble cara fuerte pero flexible con una base aluminio. **PT** Quadros de Mesa em Alumínio - Formas cortadas com precisão numa superfície de escrita forte, mas flexível de dois lados com uma base de alumínio **CZ** Stolní Tabule Aluminium - Mají nápadité tvary, jsou oboustranné, z pružného materiálu, s hliníkovým podstavcem.



Elegant

EN Elegant Table Chalkboards - Hard rubberwood base, coated with layers of quality weather-protection lacquer. Double-sided removable writing surface included (additional sets of 3 inserts available).

FR Ardoises de Table Élégantes - Se composent d'une base en bois résistante aux intempéries grâce à son vernis de protection et d'une surface d'écriture double-face flexible et amovible. (Set de 3 inserts disponible en supplément).

DE Tischkreidetafel "Elegant" - Hartgummi-Holz Sockel, beschichtet mit hochwertigem, witterungsbeständigem Schutzlack. Mit doppelseitiger Schreiboberfläche. Weitere Einsätze sind verfügbar.

IT Lavagne da Tavolo Elegant - Realizzate con un legno esotico duro di altissima qualità, con diversi strati di lacca per resistere agli agenti atmosferici. La superficie di scrittura è estraibile ed utilizzabile da entrambi i lati (Set da 3 ricambi disponibile).

ES Pizarras de Sobremesa Elegant - Base de madera dura recubierta con capas de protección contra la intemperie de calidad. Superficie de escritura extraíble de doble capa incluida (pack adicional de 3 piezas disponible).

PT Quadros de Mesa Elegantes - Madeira Exótica lacada e revestida com camadas de de proteção contra o clima. Superfície de escrita bilateral removível incluída (conjuntos adicionais de 3 inserções disponíveis).

CZ Stolní Tabule Elegant - Rám vyroben z tvrdého masivního dřeva s lakem odolným povětrnostním podmínkám. Jsou oboustranné s vyjímatelnou popisovací plochou (lze dokoupit další na výměnu po 3 ks).

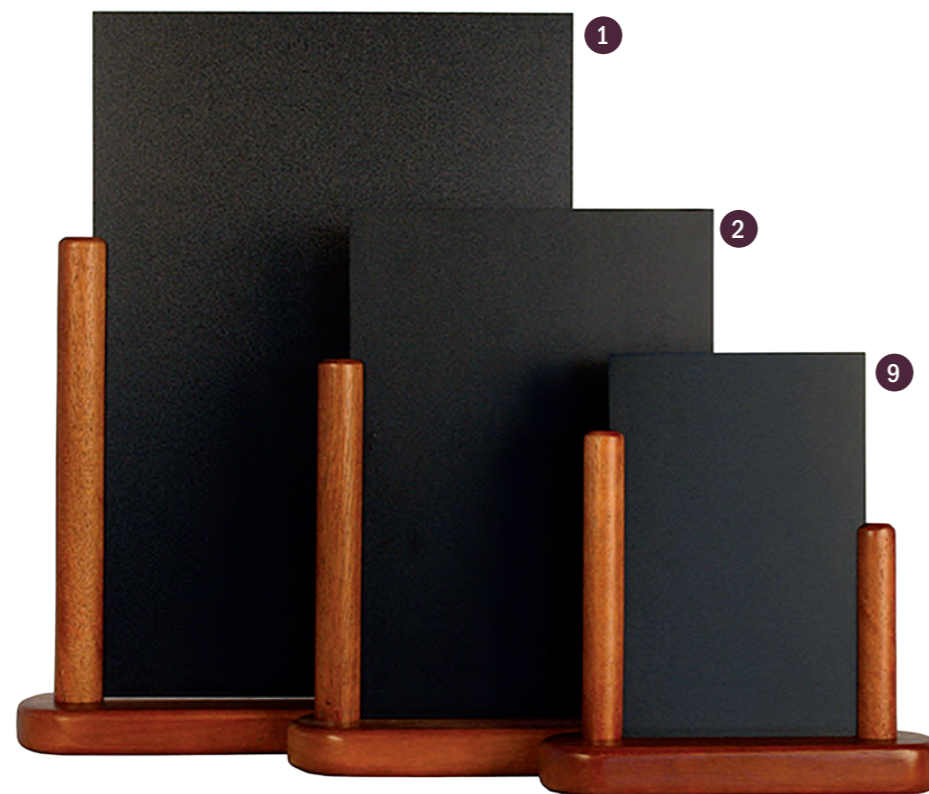

Top



1 - 6 1 ELE-DB-ME | 28x20x6cm | 0,311kg
2 ELE-DB-LA | 40x26x7cm | 0,55kg

Handle



1 - 5 3 TT-DB-LA | 53x35x7cm | 0,72kg
4 TT-DB-XL | 45x21x7cm | 0,96kg

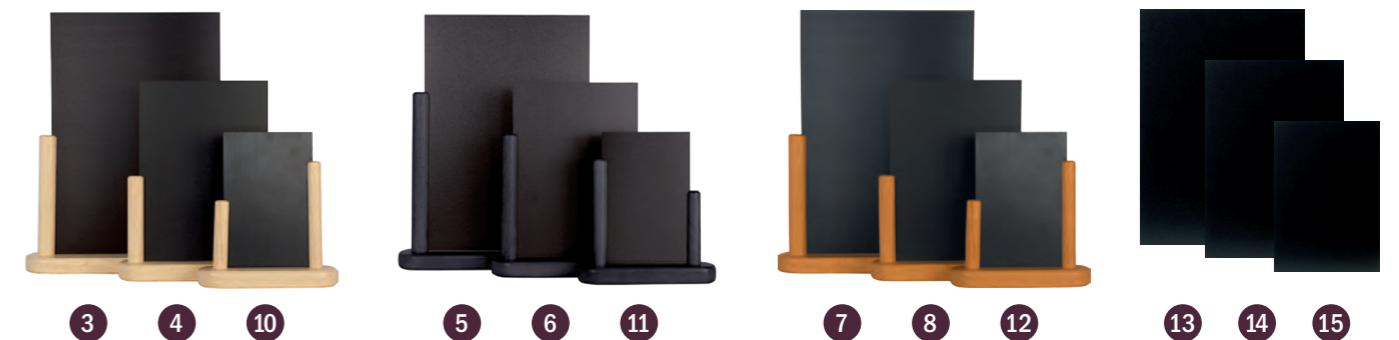

1 - 6 1 ELE-M-LA | 32x28x7cm | 0,55kg 2 ELE-M-ME | 23x20x6cm | 0,333kg 3 ELE-B-LA | 32x28x7cm | 0,55kg 4 ELE-B-ME | 23x20x6cm | 0,333kg
5 ELE-BL-LA | 32x28x7cm | 0,55kg 6 ELE-BL-ME | 23x20x6cm | 0,333kg 7 ELE-TE-LA | 32x28x7cm | 0,5kg 8 ELE-TE-ME | 23x20x6cm | 0,333kg
9 ELE-M-SM | 17x16x5cm | 0,178kg 10 ELE-B-SM | 17x16x5cm | 0,178kg 11 ELE-BL-SM | 17x16x5cm | 0,178kg
12 ELE-TE-SM | 17x16x5cm | 0,178kg 13 - 15 13 ELE-S-LA | A4 | 0,4kg 14 ELE-S-ME | A5 | 0,25kg 15 ELE-S-SM | A6 | 0,15kg



Mini



1 1x MINI +
4 3x MINI

2 1x MINI +
5 3x MINI

3 1x MINI +
6 3x MINI

1 6 54 1 MNI-B-KR-1 | 24x15x1,5cm | 0,201kg 2 MNI-M-KR-1 | 24x15x1,5cm | 0,201kg 3 MNI-BL-KR-1 | 24x15x1,5cm | 0,201kg
1 - 10 4 MNI-B-KR | 24x15x4cm | 0,32kg 5 MNI-M-KR | 24x15x4cm | 0,32kg 6 MNI-BL-KR | 24x15x4cm | 0,32kg



Sandwich mini 'POSTER & CHALKBOARD'

1 6 54 SBS-B-MNI | 24x15x3cm | 0,321kg



EN Mini and Junior Table Chalkboards - Hard wood tripod or easel style table chalkboard.

FR Ardoises de Table Mini et Junior - Trépied ou chevalet pour ardoises en bois dur. **DE** Kreidetafeln "Mini" & "Junior" - Kleine Kreidetafeln in 2 verschiedenen Formen. Mit Stativ oder als aufklappbarer Mini-Kundenstopper verfügbar. **IT** Lavagne da Tavolo Mini e Junior - Realizzate in legno duro per tutte le necessità: treppiedi o con cavalletto. **ES** Pizarras Mini y Junior para Mesa - Pizarra de sobremesa de madera dura con trípode o caballete estilo. **PT** Quadros de Mesa Mini e Junior - Tripé de madeira resistente ou de estilo cavalete quadro de mesa de estilo. **CZ** Stolní Tabule Mini a Junior - Tabulky s rámy z tvrdého dřeva ve stylech: trojnožka a stojan a Mini stojan tabule.

Junior



1 - 10 JUN-M-A4 | 36x22x5cm | 0,4kg

Bottle displays

EN Bottle Holder Chalkboards - Coated steel stand with a wooden framed chalkboard writing surface.

FR Présentoirs Bouteilles - Support en acier et ardoises avec cadre en bois. **DE** Flaschenhalter mit Kreidetafel - Pulverlackbeschichtete Stahlhalterung mit Kreidetafel. **IT** Espositore per Bottiglie - Corpo realizzato in acciaio rivestito sostiene una lavagnetta con una cornice in legno. **ES** Expositor Pizarras para Botellas con Pizarras - Soporte recubierto de acero con superficie de escritura de pizarras con marco de madera. **PT** Quadro com Suporte para Garrafas - Suporte em aço revestido com moldura de madeira e quadro de escrita.

CZ Lahvové Stojany - Vyrobeny z lakované oceli s dřevěnými doplňky a popisovací tabulkou.



1 WB-WR-1 | 45x10x12cm | 0,8kg 2 WB-WR-3 | 45x38x12cm | 2,1kg



Chalkboard tray

EN Tray Table Chalkboards - Double sided writing surface divided in three partitions.

FR Plateaux Service Ardoise - Plateau divisé en 3 parties avec une surface d'écriture en fond. **DE** Kreidetafel Serviertablett - beschreibbare drei-geteilte Oberfläche. **IT** Vassoio Lavagna - La superficie di appoggio è scrivibile su entrambi i lati e divisa in 3 spazi. **ES** Pizarra Bandeja - Superficie de escritura de dos caras con división en tres partes. **PT** Tabuleiro de Mesa com Quadro - Superfície de escrita bilateral com uma divisão em três partes. **CZ** Popisovatelné Podnosy - S rozdělenou plochou na 3 části, povrch je vhodný pro použití křídových popisovačů.



1 RST-DB-60 | 60x40x4cm | 2,48kg 2 RST-DB-40 | 40x40x4cm | 1,9kg



Table caddy

EN Wood Based Table Chalkboard - Menu holding table caddy with double sided writing surface and handle mounted on a hard wooden base with metal framework.

FR Ardoises de Table sur socle bois - Porte-menu de Table portatif avec une surface d'écriture sur les deux faces et une anse montée en bois dure sur une structure en métal. **DE** Tisch Aufsteller - Menühalter mit Platz für Menagen. **IT** Lavagna portamenu e portacondimenti - Lavagna con manico, scrivibile su entrambi i lati.

Montato su una solida base di legno con struttura in metallo. **ES** Pizarra Porta menús y condimentos - Pizarra con mango, puede escribir en ambos lados. Montado sobre una base de madera sólida con estructura de metal. **PT** Menu de mesa - Menu mesa com suporte de madeira com dupla face. Superfície apta para escrita. É montado na base de madeira sólida e com estrutura metálica. **CZ** Stolní stojánek se 2 popisovatelnými tabulkami pro umístění jídelního lístku. Rám je vyroben z masivního dřeva s kovovými rámečky.



Chalkboards Tags



TAG-HLD-BL
P.37

TBA-BL-A5
P.35

TAG-HLD-TR
P.37



Bottle tag

EN Bottle Tag Chalkboards - Double-sided flexible and washable chalkboard tag.

FR Ardoises bouteille Tag - Ardoises doubleface flexible, faciles à nettoyer. **DE** Flaschenetikett - Doppelseitige, flexible und abwaschbare Kreidetafelschilder zur einfachen Beschriftung von Flaschen. **IT** Etichette Tag Bottiglia - Sono lavabili, flessibili e scrivibili su entrambi i lati. **ES** Pizarras Etiquetas Botella Tag - Pizarras etiquetas y soportes de doble cara flexibles y lavables. **PT** Etiquetas de Quadros Garrafa - Etiquetas e Tags bilaterais flexíveis e laváveis. **CZ** Láhev Tabulky Tag - Oboustranně popisovatelné, omývatelné, s možností připevnění na stojánku.

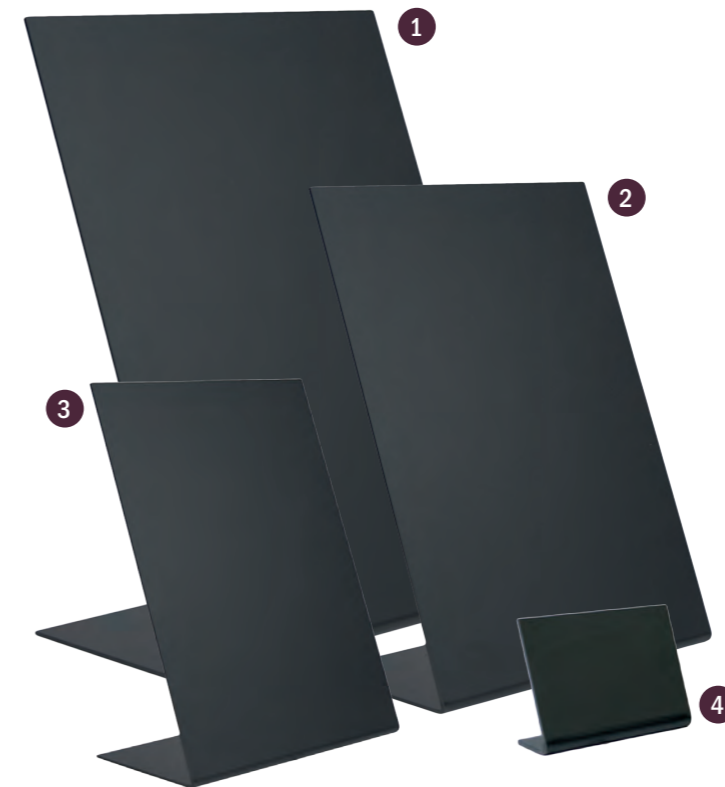

L-boards

EN L-Shape Chalkboards - Robust and stable acrylic chalkboard with a frosted front and a gloss back.

FR Ardoises en Forme de L - Ardoises en acrylique noire très résistantes et très stables. Finitions mat sur le devant et brillant au dos. **DE** L-boards: L-Förmige Kreidetafeln - Robuste und stabile Acryl-Kreidetafel mit einer matten Vorder- und glänzenden Rückseite. **IT** Lavagne a Forma di L - Realizzate in acrilico nero opaco sul fronte ed un retro glassato lucido. **ES** Pizarras con Forma de L - Pizarra acrílica robusta y estable con la parte frontal mate y la parte posterior brillante. **PT** Quadros em Forma de L - Quadro em acrílico robusto e estável com uma frente fosca e uma parte de trás brilhante. **CZ** Stojánkové Popisovací Tabulky typu L - Vyrobeny z akrylátu s přední popisovatelnou a zadní lesklou plochou.

3	6	24	1	TBA-BL-A5	21x14,8x9cm	0,458kg
3	6	36	2	TBA-BL-A6	14,8x10,5x5cm	0,198kg
5	6	36	3	TBA-BL-A7	10,5x7,4x5cm	0,166kg
5	6	120	4	TBA-BL-A8	7,4x5,2x3,5cm	0,1kg

NEW

x10



1 6 60 TAG-B0-WT | 16x6,5x0,1cm | 0,1kg

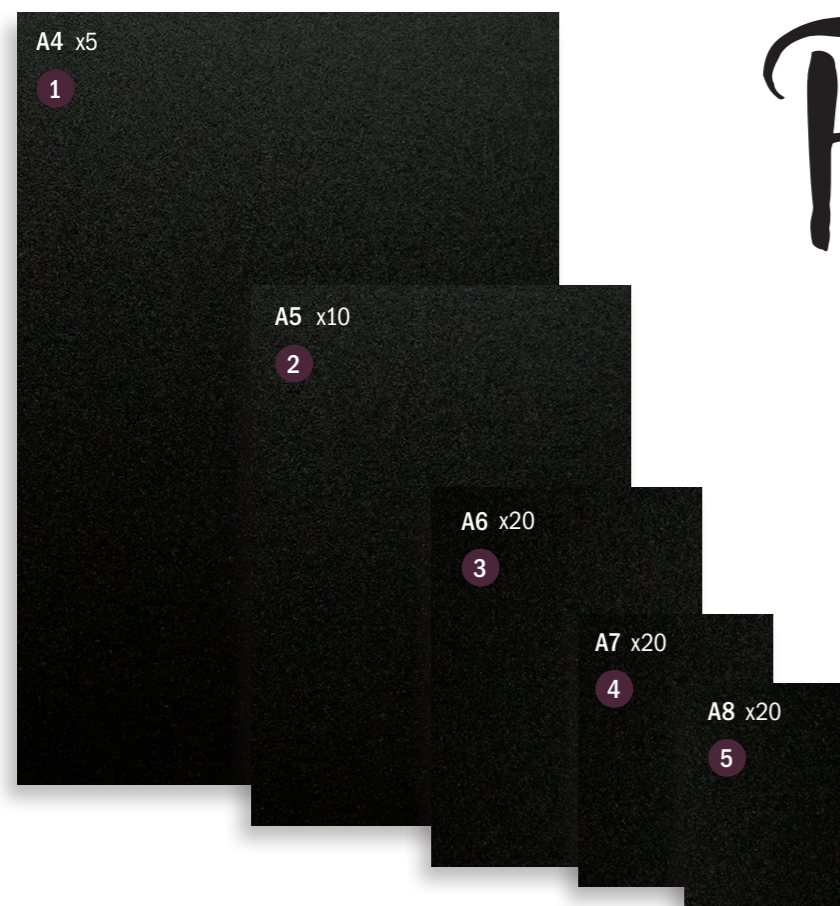

- 5 5 15 1 TAG-A4-WT | 29,7x21x0,2cm | 0,28kg
- 10 5 15 2 TAG-A5-WT | 21x14,8x0,2cm | 0,28kg
- 20 5 15 3 TAG-A6-WT | 14,8x10,5x0,2cm | 0,25kg
- 4 TAG-A7-WT | 10,5x7,4x0,2cm | 0,154kg
- 5 TAG-A8-WT | 7,4x5,2x0,2cm | 0,1kg



Black and White Tags



EN Chalk- & Whiteboard Tags - Double-sided flexible and washable chalk and whiteboard tags plus holders.

FR Ardoises & Tableau Blanc Tags - Ardoises et Tableau Blanc Tags doubleface flexible, faciles à nettoyer, avec supports inclus.

DE Whiteboard-Tag & Kreidetafelschild - Doppelseitige, flexible und abwaschbare Whiteboard-Tags und Kreidetafelschilder mit Halter. **IT** Lavagne Tag Bianche e Nere - Sono lavabili, flessibili e scrivibili su entrambi i lati. Utilizzabili ovunque grazie alle basi.

ES Pizarras Etiquetas Tag - Pizarras etiquetas y soportes de doble cara flexibles y lavables. **PT** Etiquetas de Quadros - Etiquetas e Tags bilaterais flexíveis e laváveis. **CZ** Tabulky Tag - Oboustranně popisovatelné, omývateľné, s možnosťou pripevnení na stojánku.

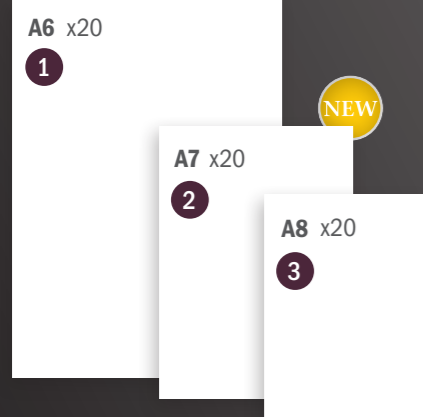

- 20 5 15 1 TAG-A6-BL | 14,8x10,5x0,2cm | 0,25kg
- 2 TAG-A7-BL | 10,5x7,4x0,2cm | 0,15kg
- 3 TAG-A8-BL | 7,4x5,2x0,2cm | 0,1kg



1 CLAMP

SPIKE 2



HOLDER 3



CLIP 4

WOOD 5



- 1 TAG-HLD-AC | 10x2,5x2,5cm | 0,1kg
- 2 TAG-HLD-BL | 4x6x2cm | 0,066kg
- 3 TAG-HLD-TR | 4x6x2cm | 0,087kg
- 4 TAG-HLD-CP | 5,5x1,4x1,7cm | 0,02kg
- 5 TAG-HLD-TE | 2,5x2,5x2,5cm | 0,06kg
- 6 TAG-VELCRO | 9,5x6,5x2,5cm | 0,045kg

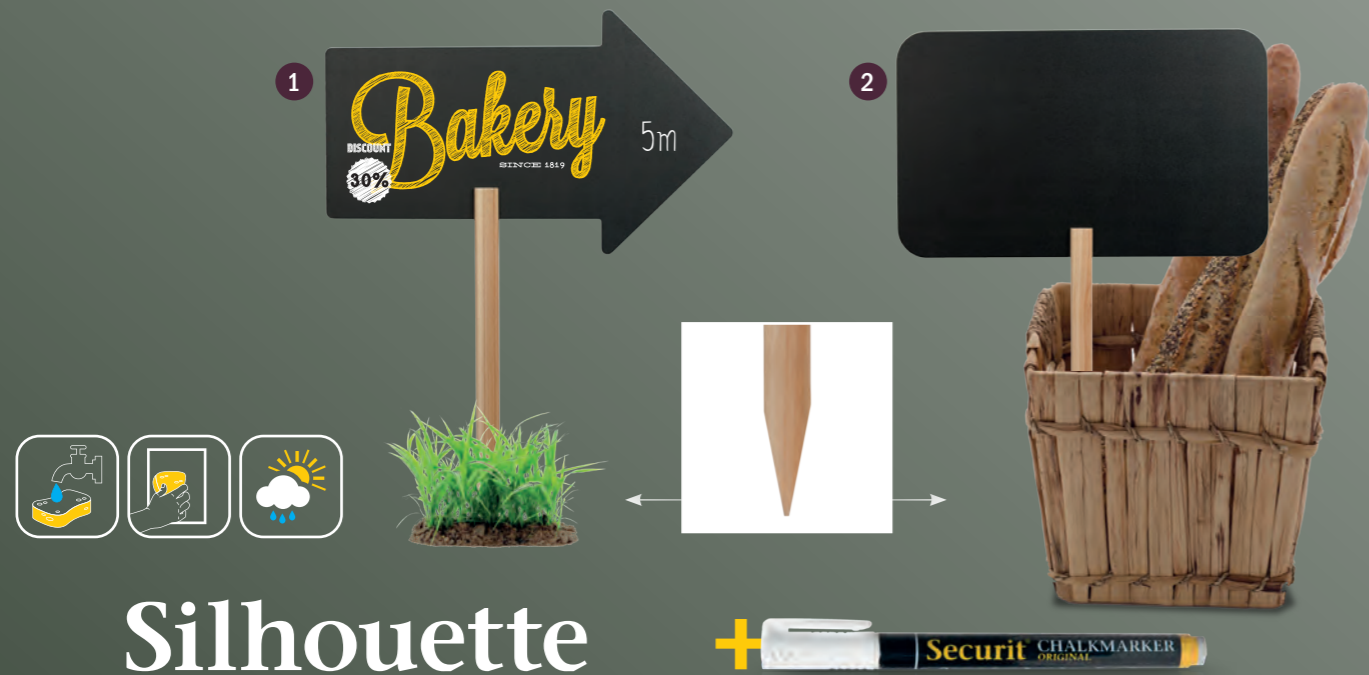

Silhouette tag/stick

EN Spike Chalkboards - Precision cut shapes from a strong, yet flexible, double sided writing surface with an integrated spike for displaying in any soft surface.

FR Pancartes/ Silhouette - Surface d'écriture flexible aux formes originales, à planter dans toutes surfaces meubles grâce à son pic en bois inclus. **DE** Doppelseitige Kreidetafel mit Erdstecker - Präzisionsgeschnittene Formen auf einer starken, doch flexiblen, doppelseitigen Schreiboberfläche mit integriertem Stab. der in jede weiche Oberfläche gesteckt werden kann. **IT** Lavagne

con Punta - Le forme sono realizzate con grande precisione su una superficie flessibile utilizzabile da entrambi i lati. Grazie alla punta possono essere inserite in qualsiasi materiale con superficie morbida. **ES** Pizarras con Pincho - Precisas formas recortadas en una superficie de escritura de dos caras fuerte pero flexible, con un clavo integrado para usarla en cualquier superficie. **PT** Quadros Espigados - Formas cortadas com precisão numa superfície de escrita resistente mas flexível, com um pico integrado para exibição em qualquer superfície mole. **CZ** Zapichovací Tabulky - Mají přesné tvary, jsou oboustranně popisovatelné s bodcovým stojánkem pro upevnění do měkkého materiálu.

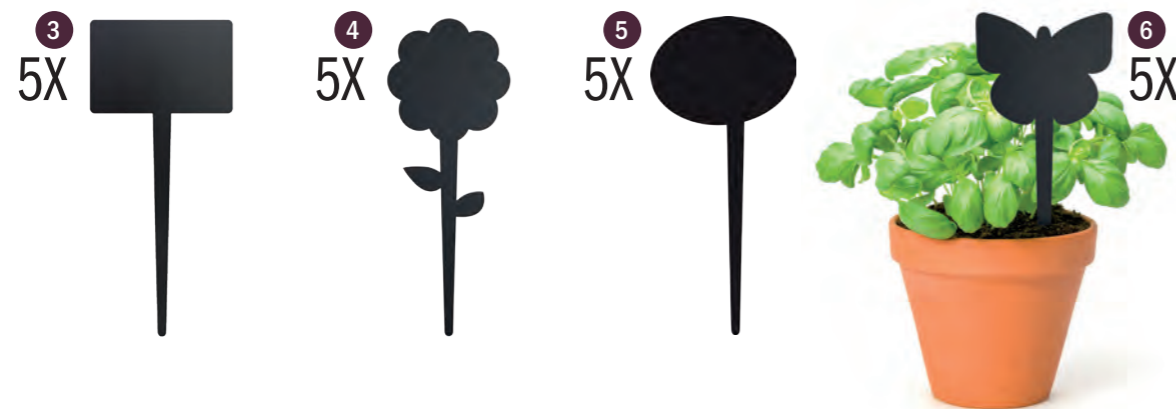

1 6 60 1 FBS-ARROW | 73x45x2,5cm | 0,483kg 2 FBS-RECTANGLE | 73x45x2,5cm | 0,483kg 1 6 120 3 TAG-RECTANGLE-5 | 18x8x1,5cm | 0,212kg 4 TAG-FLOWER-5 | 18x8x1,5cm | 0,212kg 5 TAG-BUBBLE-5 | 18x8x1,5cm | 0,212kg 6 TAG-BUTTERFLY-5 | 18x8x1,5cm | 0,212kg



Signs



EN Acrylic Table Signs - Stackable and washable.

FR Numéros de Table - Empilables et lavables. **DE** Tisch-Aufsteller - Stapelbar und abwaschbar. **IT** Numeri per i Tavoli - Segnatavoli lavabili in acrilico. **ES** Carteles Mesa - Apilables y lavables, en acrílico. **PT** Sinais de Mesa em Acrílico - Empilháveis e laváveis. **CZ** Stolní Informační Tabulky.

1 6 60 1 TN-1-10-WT, TN-11-20-WT, TN-21-30-WT, TN-31-40-WT, TN-41-50-WT, TN-51-60-WT | 5x4x5cm | 0,132kg
1 6 60 2 TN-RES-DE-WT, 3 TN-RES-EN-WT, 4 TN-RES-FR-WT, 5 TN-RES-ES-WT, 6 TN-RES-IT-WT, 7 TN-RES-NL-WT | 5x10x5cm | 0,155kg
1 6 60 8 TAG-SBS-WT | 17x5x0,3cm | 0,1kg



Writable mini sandwich

EN Mini Table Sandwich Writable Sign - Flexible, Double-sided and washable chalkboard table sign.

FR Mini Chevalet trottoir de Table - Ardoise de Table flexible, double-face et lavable facilement. **DE** Mini Sandwichboards - flexiblen, doppelseitiges, beschreibares und abwaschbares Tisch-Sandwichboard. **IT** Lavagna Sandwich Mini - lavagne resistenti, scrivibili su ambo i lati e facili da pulire. **ES** Pizarra Sandwich Mini - pizarras resistentes, se puede escribir en ambos lados y fácil de limpiar. **PT** Menu de mesa sandwiche - Pode ser escrito de ambos os lados e é fácil de limpar. **CZ** Malá stolní tabulka pro použití křídových popisovačů. Je oboustranná a omyvatelná.



Coffee stencils

EN Coffee stencils - Stainless steel stencils to make a face- or heart shape in your coffee or other hot beverage.

FR Pochoirs à café - En acier inoxydable, permet de faire des décorations amusantes (visage et coeur) dans votre tasse de café ou autres boissons chaudes. **DE** Edelstahl Kaffeeschablonen - Gesicht- & Herzform. 2er-Set - Blisterverpackung.

IT Stencil decorativo per caffè - Stencil in acciaio inossidabile per creare

una faccia o una smile a cuore sul cappuccino o altra tua bevanda calda.

ES Plantillas decorativas para el café - Plantillas en acero inoxidable para crear una cara o una forma de corazón sobre el café o una bebida caliente.

PT Stencils para café - stencils do aço inoxidável para fazer uma cara ou coração em café ou bebida quente.

CZ Šablony pro zdobení horkých nápojů. Jsou vyrobeny z nerezové oceli pro snadné a rychle ozdobení cappuccina nebo jiných horkých nápojů.



1 6 60 STN-SS-CO | 12,4x10x0,1cm | 0,1kg

Securit®
BACK TO
BLACK
SELECTION

MCS-4A4-BL-SET
P.118



WBW-BL-40-50
P.49

MC-BOX-CRA4-BL
P.84



TBA-BL-A5
P.35



PIZARRAS
DE PARED

WAND
KREIDETAFFELN

Quadros
de parede

FB-CB-HEX
P.54

PNT-BL-SM/
PNT-BL-LA
P.58

Ardoises
murales

WBU-B-40
P.45

NÁSTĚNNÉ
POPISOVACÍ
TABULE



Savagne
d'a parete

Wall Chalkboards & cork

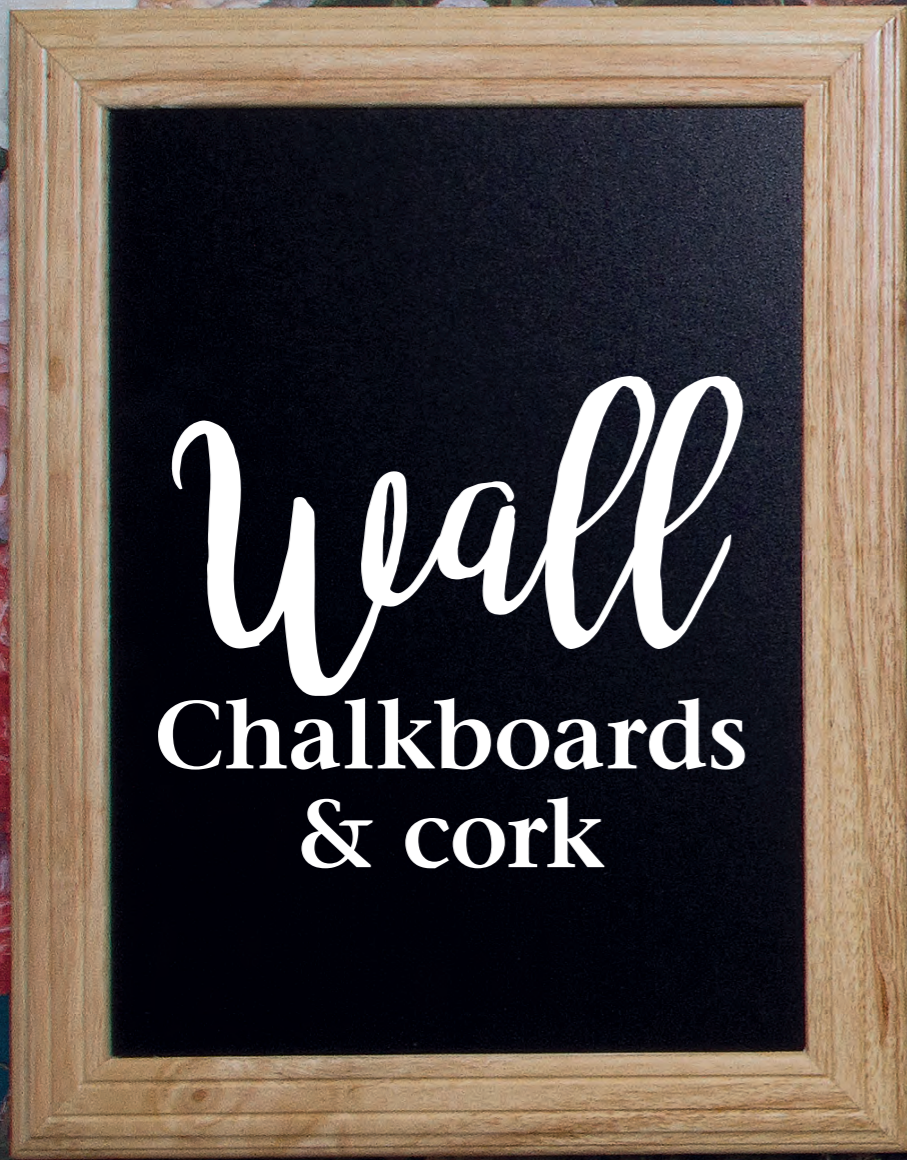

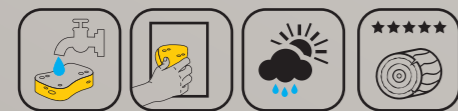

Universal/ long

EN Universal Wall Chalkboards - Heavy duty rubberwood frame, coated with layers of quality weather-protection lacquer. Available in a variety of styles and finishes, such as traditional curved, grooved or flat. All have a double-sided writing surface and a flat modern back design.

FR Ardoises Murales Universal - Cadre en bois dur, résistant aux intempéries grâce au vernis de protection qui le recouvre. Finitions arrondies, rainurées ou plates.

DE Universelle Wandkreidetafel - Mit hochwertigem, witterungsbeständigen Schutzlack beschichteten Hartgummi-Holz. Erhältlich in verschiedenen Formen und Ausführungen. Alle haben eine beidseitige Schreiboberfläche. **IT** Lavagne da Parete Universal - Hanno una cornice in legno duro trattato con diversi strati di lacca per renderlo resistente agli agenti atmosferici. Disponibile in diversi colori e finiture come: curvo, scanalato e liscio. Il retro è scrivibile con una cornice moderna e piatta. **ES** Pizarras de Pared Universal - Marco de madera dura de alto rendimiento, recubierta de capas de laca protectora contra la intemperie. Alta calidad. Disponible en varios estilos y acabados, como la tradicional curvada, acanalada o lisa. Todas tienen superficie de escritura de doble cara y un diseño posterior plano y moderno. **PT** Quadros de Parede Universais - Madeira Exótica resistente, lacada e revestida com camadas de proteção contra o clima. Disponíveis numa variedade de estilos e acabamentos, como com curva tradicional, ranhuras ou liso. Todos com uma superfície de escrita bilateral e um design traseiro moderno. **CZ** Nástěnné Tabule Universal - Rám je z tvrdého gumovníkového dřeva s lakem odolným povětrnostním podmínkám. V nabídce různé barvy a tvary rámu - zaoblený, drážkovaný nebo hladký. Jsou oboustranné s moderním hladkým rámem ze zadní strany.



- 1 5
 1 **WBU-BL-40** | 40x50x3,5cm | 1,8kg
 1
 3 **WBU-BL-60** | 60x80x3cm | 3,4kg
 4 **WBU-BL-70** | 70x90x3,5cm | 4,6kg

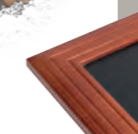

- 1 5
 1 **WBU-M-40** | 40x50x3,5cm | 1,8kg
 2 **WBU-M-50** | 50x60x3cm | 1,92kg
 1
 3 **WBU-M-60** | 60x80x3cm | 3,4kg
 4 **WBU-M-70** | 70x90x3,5cm | 4,6kg
 5 **WBU-M-80** | 80x100x3cm | 5kg

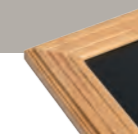

- 1 5
 1 **WBU-B-40** | 40x50x3,5cm | 1,8kg
 1
 3 **WBU-B-60** | 60x80x3cm | 3,4kg
 4 **WBU-B-70** | 70x90x6cm | 4,6kg

UNIVERSAL

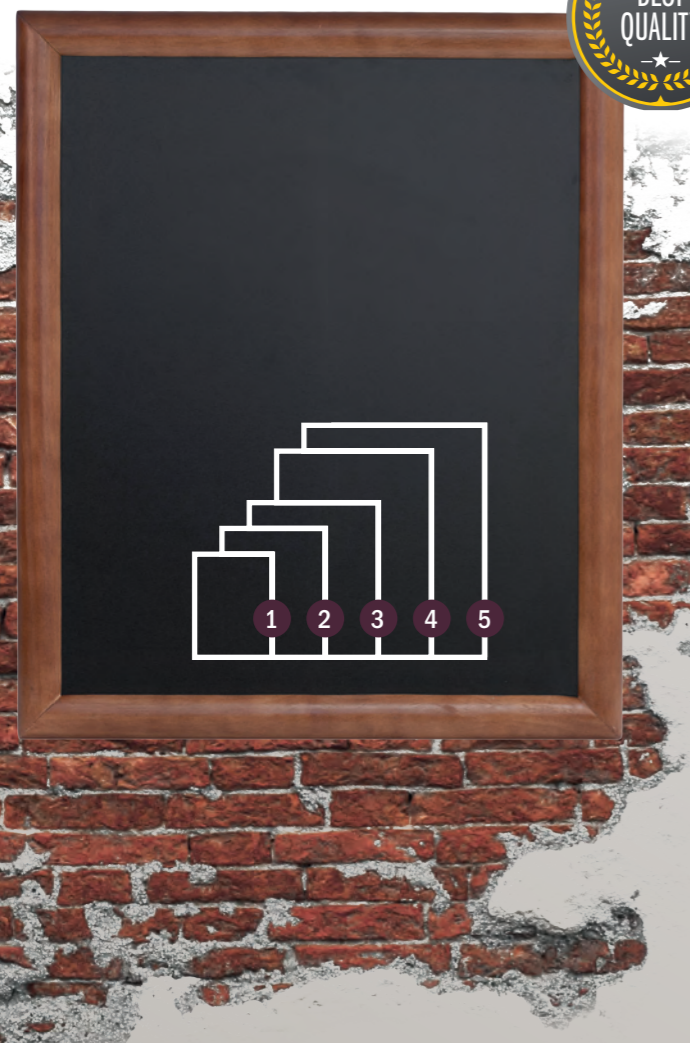

LONG

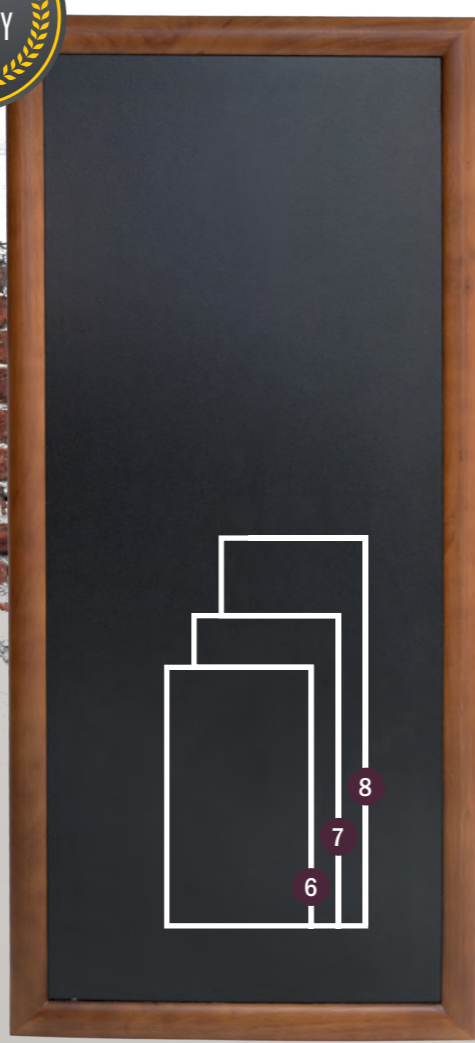

UNIVERSAL



- 1 **WBU-DB-30** | 30x40x3cm | 1,12kg
- 2 **WBU-DB-40** | 40x50x3,5cm | 1,8kg
- 3 **WBU-DB-50** | 50x60x3cm | 1,92kg
- 4 **WBU-DB-60** | 60x80x3cm | 3,4kg
- 5 **WBU-DB-70** | 70x90x3,5cm | 4,6kg

LONG



- 6 **WBL-DB-100** | 100x56x4cm | 5,4kg
- 7 **WBL-DB-120** | 120x56x4cm | 6,4kg
- 8 **WBL-DB-150** | 150x56x5cm | 8,02kg



- 2 **WBU-TE-40** | 40x50x3,5cm | 1,8kg
- 3 **WBU-TE-50** | 50x60x3cm | 1,92kg
- 4 **WBU-TE-60** | 60x80x3cm | 3,4kg
- 5 **WBU-TE-70** | 70x90x3,5cm | 4,6kg



- 6 **WBL-TE-100** | 100x56x4cm | 5,4kg
- 7 **WBL-TE-120** | 120x56x4cm | 6,4kg
- 8 **WBL-TE-150** | 150x56x4cm | 6,45kg



EN Gold Wall Chalkboards - Sophisticated engraved frame protected by a luxurious gold coating.

FR Ardoises Murales Dorées - Cadre aux moulures travaillées couleur or. **DE** Goldene Kreidetafel mit anspruchsvollem eingraviertem Goldrahmen. **IT** Lavagna da Parete Gold - Una sofisticata lavagna rivestita con una elegantissima cornice color oro. **ES** Pizarras de Pared Gold - Sofisticado marco grabado protegido por una capa de oro. **PT** Quadros de Parede Dourados - Moldura gravada sofisticada protegida por uma cobertura dourada. **CZ** Nástěnné Tabule Gold - Mají zdobený rám s povrchovou úpravou ve zlaté barvě.

- 1 **WBC-G-105** | 105x75x10cm | 10,2kg
- 2 **WBC-G-85** | 85x65x10cm | 7,6kg

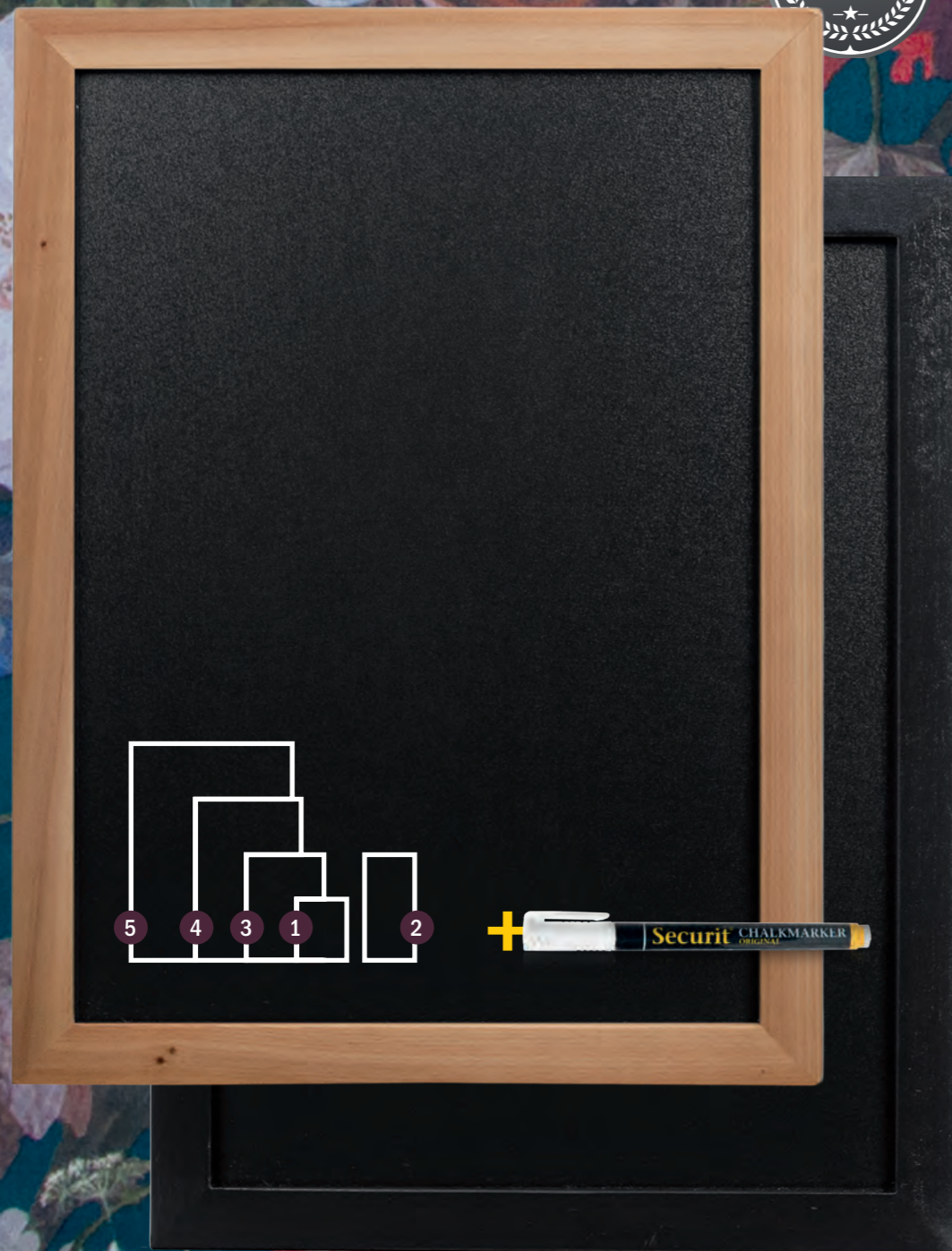

Woody

EN Woody Wall Chalkboards - Low cost, high quality chalkboards with a strong wooden design frame and a double-sided writing surface.

FR Ardoises Murales Woody - Ardoises de qualité à faible coût et cadre en bois résistant.

DE Wandkreidetafeln "Woody" - kostengünstiges Qualitätsprodukt mit Rahmen in Holzoptik.

Doppelseitig beschreibbar. **IT** Lavagne da Parete Woody - Sono le lavagne più economiche del mercato, utilizzabili da entrambi i lati con una cornice in legno di alta qualità.

ES Pizarras de Pared Woody - Pizarras de bajo coste y alta calidad con un marco de diseño de madera dura con superficie de escritura de doble cara.

PT Quadros de Madeira para Paredes - Quadros de baixo custo, alta qualidade com uma moldura de design de madeira resistente com uma superfície de escrita bilateral.

CZ Nástěnné Tabule Woody - Levné kvalitní tabule z masivního dřeva v oboustranném provedení.



- 1 6 36
- 1 **WBW-BL-20-24** | 20x24x1cm | 0,328kg
- 1 6 24
- 2 **WBW-BL-20-40** | 20x40x1cm | 0,416kg
- 3 **WBW-BL-30-40** | 30x40x0,5cm | 0,592kg
- 1 6 12
- 4 **WBW-BL-40-60** | 40x60x0,5cm | 1,03kg
- 1 - 6
- 5 **WBW-BL-60-80** | 60x80x0,5cm | 1,2kg



- 1 6 36
- 1 **WBW-TE-20-24** | 20x24x1cm | 0,328kg
- 1 6 24
- 2 **WBW-TE-20-40** | 20x40x1cm | 0,416kg
- 3 **WBW-TE-30-40** | 30x40x0,5cm | 0,592kg
- 1 6 12
- 4 **WBW-TE-40-60** | 40x60x0,5cm | 1,03kg
- 1 - 6
- 5 **WBW-TE-60-80** | 60x80x0,5cm | 1,2kg

New Silhouette

EN Silhouette Wall Chalkboards - Precision cut shapes from a strong, flexible double sided writing surface.

FR Ardoises Murales Silhouette - Surface d'écriture double face flexible, aux formes originales. **DE** Wandkreidetafel "Silhouette" - Präzisionsgeschnittene Formen auf einer starken, doch flexiblen, doppelseitigen Schreiboberfläche. Erhältlich in verschiedenen Formen. **IT** Lavagne da Parete Silhouette - Belle, flessibili, leggere, originali ed utilizzabili da entrambi i lati. **ES** Pizarras de Pared Siluetas - Formas recortadas con precisión en superficie de escritura de doble cara fuerte pero flexible. **PT** Quadros de Parede em Forma de Silhueta - Formas cortadas com precisão numa superfície de escrita bilateral resistente mas flexível. **CZ** Nástěnné Tabule Silhouette - Nápadité tvarované oboustranné tabule z ohebného materiálu.

4x

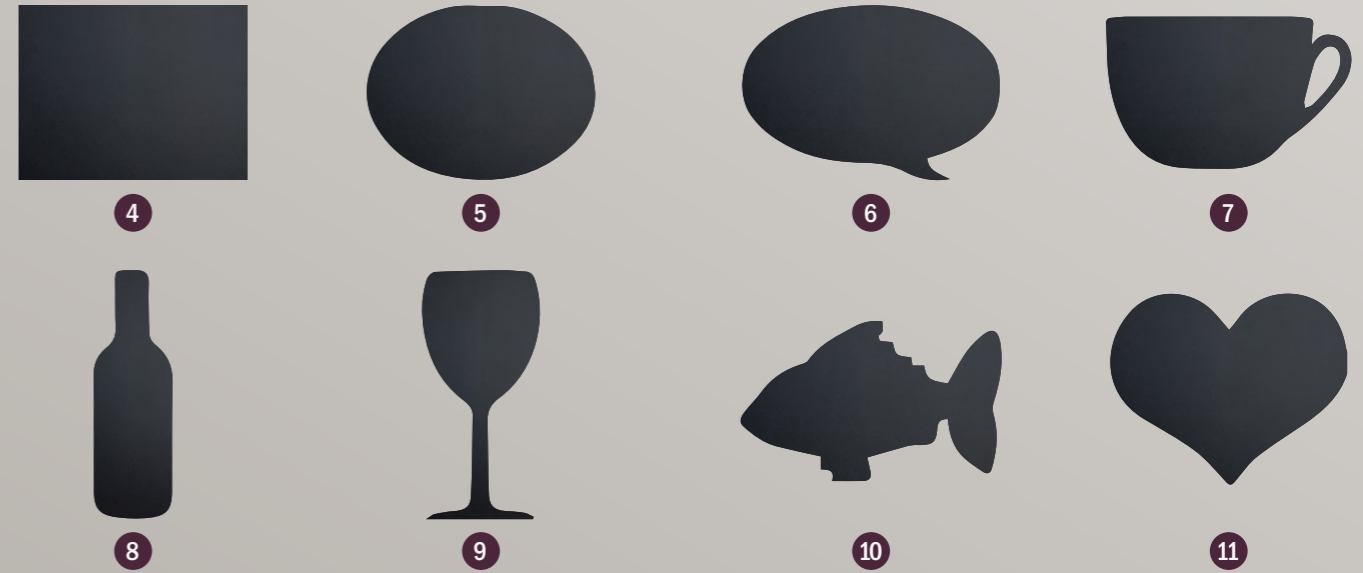
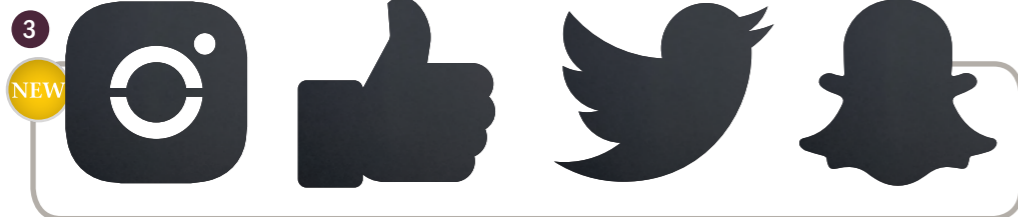

KIDS MENU



1 6 60

- 1 FB-WIFI | 38x25x0,3cm | 0,3kg
- 2 FB-MOKA | 38,8x29x0,3cm | 0,3kg
- 3 FB-SM4 | 38x25x0,3cm | 0,3kg
- 4 FB-SQUARE | 35x30x0,3cm | 0,26kg
- 5 FB-OVAL | 38x30x0,3cm | 0,26kg
- 6 FB-BUBBLE | 57x32x0,3cm | 0,26kg
- 7 FB-CUP | 29x44x0,3cm | 0,26kg
- 8 FB-BOTTLE | 50x19x0,3cm | 0,26kg
- 9 FB-GLASS | 50x23x0,3cm | 0,26kg
- 10 FB-FISH | 30x49x0,3cm | 0,26kg
- 11 FB-HEART | 30x36x0,3cm | 0,26kg
- 12 FB-FLOWER | 43x39x0,3cm | 0,26kg
- 13 FB-CAR | 49x24x0,3cm | 0,26kg
- 14 FB-CLOUD | 48x29x0,3cm | 0,26kg
- 15 FB-STARS | 24x24x0,3cm | 0,26kg
- 16 FB-BEAR | 40x30x0,3cm | 0,26kg
- 17 FB-BUTTERFLY | 36x30x0,3cm | 0,26kg
- 18 FB-CAT | 46x29x0,3cm | 0,26kg
- 19 FB-CHICKEN | 36x29x0,3cm | 0,26kg
- 20 FB-DOLPHIN | 24x50x0,3cm | 0,26kg
- 21 FB-HORSE | 27x36x0,3cm | 0,26kg
- 22 FB-DINO | 47x30x0,3cm | 0,26kg





Living wall

EN Living Wall Cork/ Chalkboard - Smooth writing surface on thick solid wood with embedded cork pin boards.

FR Pense-bête Living Wall - Surface d'écriture en imitation béton sur bois dur avec de petites pièces en liège intégrées et bordures en métal.

DE Living Wall Kork/Kreidetafel - Beschreibbare Tafel aus Holz mit eingelassenen Korkplatten.

IT Lavagna-Bacheca da parete Living Wall - Una robusta superficie di scrittura realizzata in legno massiccio di colore grigio cemento con un moderno contorno in acciaio inox. Finestre in sughero. **ES** Pizarra de pared en corcho - Una superficie de escritura realizada en una madera maciza de color gris hormigón con un contorno moderno en acero inoxidable. **PT** Ardósia de parede - superfície apta para escrita com caicilho de madeira. **CZ** Living Wall - panel z masivního dřeva s hladkým povrchem pro použití křídových popisovačů a vloženými korkovými tabulkami.



Design and functionality

EN Silhouette Wall Chalkboards - Precision cut shape from a strong, flexible writing surface and actual clock mechanism.

FR Silhouette murale Ardoise - forme coupée avec précision, support rigide, surface d'écriture flexible et mécanisme horloge. **DE** Silhouette Uhr Kreidetafel - präzise geformte, starke, doch flexible, beschreibbare Kreidetafeloberfläche mit Uhrfunktionsmechanismus. Wochenplaner mit Stift- und Schlüsselhalterung. **IT** Lavagna Orologio Silhouette - Un orologio originale che permetterà di personalizzare la propria giornata e non perdere più nessun appuntamento. **ES** Pizarra silueta de Reloj - Un reloj original que permite personalizar el día y nunca faltar a una cita. **PT** Ardósia em forma de relógio - Um relógio original que permite personalizar cada dia com uma frase diferente.

CZ Nástěnné Tabule Silhouette - Nápaditě tvarované tabule z ohebného materiálu s hodinovým mechanismem.



1 CLOCK



2 WEEKPLANNER

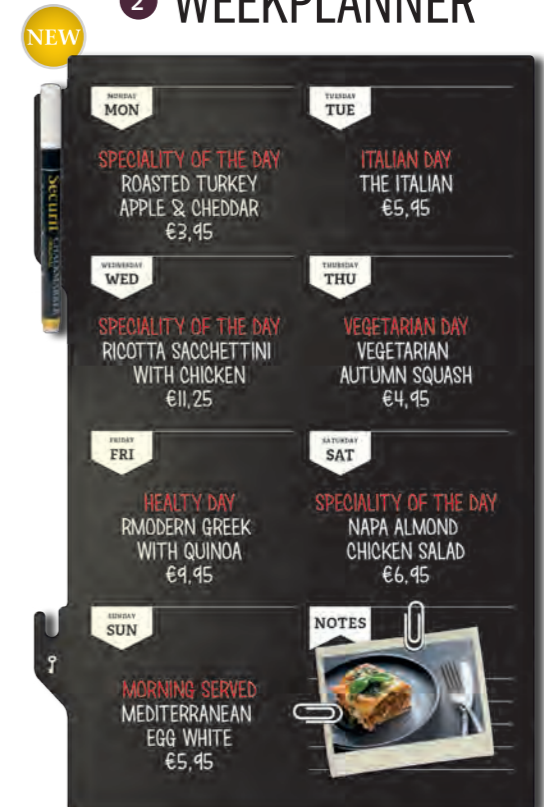

Hexagon

EN Silhouette Wall boards - Precision cut shapes from a strong, flexible double sided writing surface and cork.

FR Silhouette murale - Forme coupée avec précision en liège ou avec surface d'écriture, double-face et rigide. **DE** SSechseck Kork- und Kreidetafeln - präzise geformte, starke und doch flexible Oberflächen. Beidseitig beschreibbar. **IT** Lavagne e bacheche esagonali Silhouette- Esagoni in sughero e lavagna

ritagliati con precisione per decorare e comunicare su qualsiasi parete. **ES** Pizarras Hexagonales - hexágonos en corcho y pizarra flexible, cortadas con precisión para decorar y comunicar en cualquier pared. **PT** Quadros de parede - Com vários formas e cortes. Flexível dupla face para escrita. **CZ** Nástěnné Tabule Silhouette - Nápaditě tvarované tabule z ohebného popisovatelného materiálu a korku.



Cork boards

EN Cork Wall Silhouette pin boards - Precision cut shapes with self-adhesive mounting pads.

FR Silhouettes en liège - Pêle-mêle aux formes amusantes à fixer au mur grâce aux petits patches double-face fournis.

DE Korkwand Silhouettentafel - Präzisionsgeschnittene Motive aus Kork. Selbstklebend mit Pinnadeln. **IT** Bacheche in sughero Silhouette da parete - Forme realizzate con precisione e montate a parete con cuscineti biadesivi. **ES** Pizarras de pared de

corcho con silueta - Formas creadas con precisión para poner en la pared con almohadillas adhesivas de doble cara.

PT Quadros de parede Silhouette em cortiça - Formas cortadas com precisão. Inclui bandas adesivas para aplicação.

CZ Korková tvarovaná nástěnka Silhouette - je přesně tvarovaná, s lepicími páskami pro montáž na stěnu.





Letter shelf

EN Letter Shelf - Wooden shelf of 1 meter to mount on the wall. This wooden shelf will present the included letters and numbers.

FR Étagère Lettre - Étagère en bois de 1 Mètre de long à monter sur le mur. Cette étagère en bois présentera les lettres et nombres inclus à poser. **DE** Buchstabenleiste inkl. Buchstaben und Zahlen - hölzerne Leiste (1 m), um die in der Packung enthaltenen Buchstaben zu präsentieren.

IT Mensola porta messaggi - Lunga 1m e facile da fissare al muro. Una mensola che funge da appoggio per lettere e numeri con i quali si possono scrivere frasi e note.

ES Estantería porta mensajes - 1 m de longitud y fácil de fijar a la pared. Una estantería que actúa como soporte de letras y números para escribir frases y notas. **PT** Prateleira porta mensagens - com um metro de altura, fácil de fixar na parede. Uma prateleira que serve de suporte para letras e números ou para escrever notas ou frases. **CZ** Polička na písmena. Dřevěná 1 metr dlouhá polička na stěnu pro snadnou prezentaci informací poskládaných z písmen a číslic.

25cm + 25cm + 25cm + 25cm = 100cm

A x8	O x6	0 x4	f x1	€ x2
B x3	P x3	1 x4	🐦 x1	£ x2
C x4	Q x2	2 x3	@ x1	\$ x2
D x5	R x6	3 x3	📌 x1	- x2
E x7	S x6	4 x3	👤 x1	. x3
F x3	T x6	5 x4	@ x1	, x3
G x3	U x5	6 x3	📶 x1	
H x3	V x2	7 x3	# x1	
I x6	W x3	8 x3	♥ x1	
J x2	X x1	9 x4	x3	
K x2	Y x2			
L x6	Z x2			
M x5	ß x2			
N x6				

x169

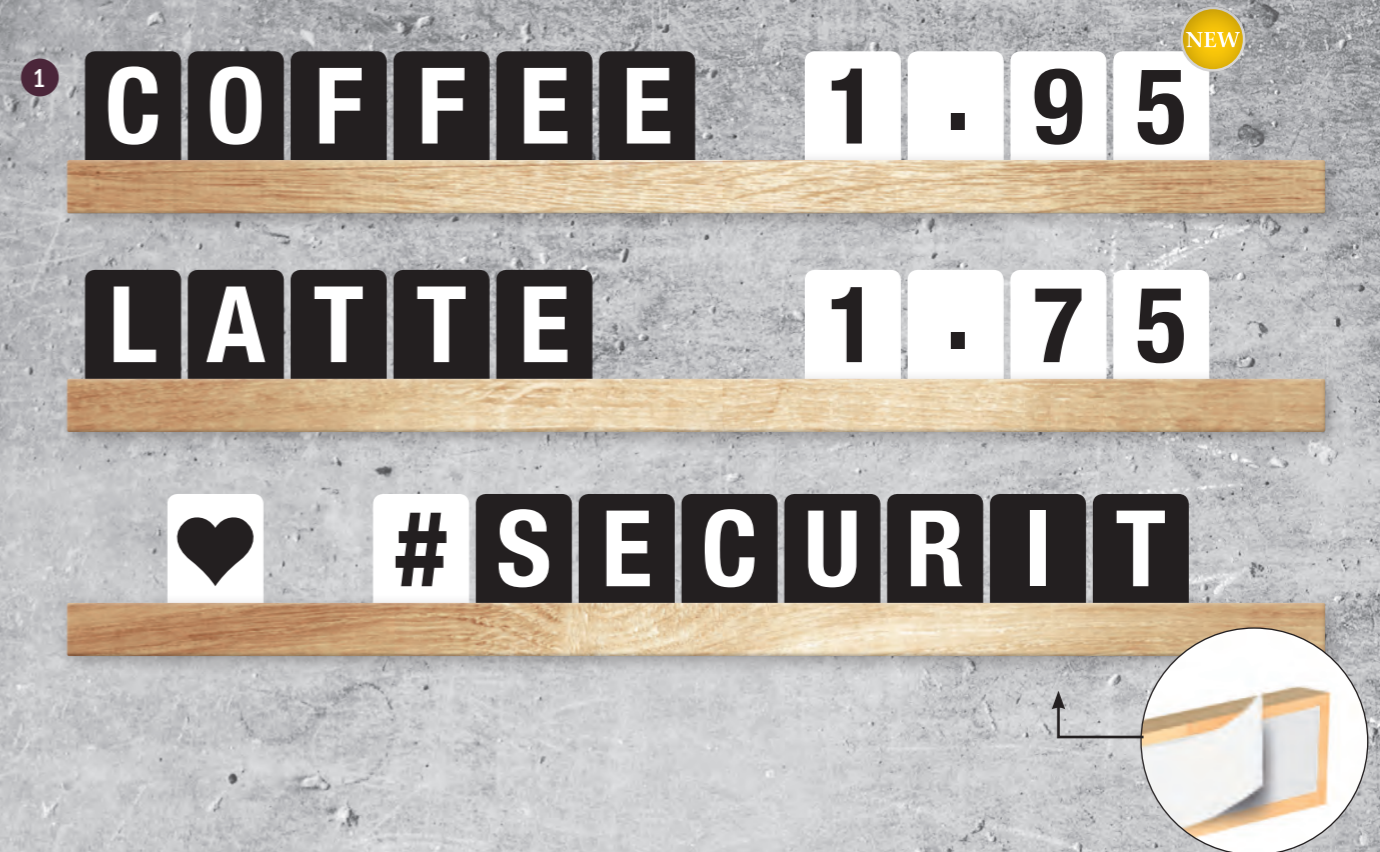

1 | 6 | 60 | 1 LES-TE-100 | 100cm | 0,2kg 2 LES-BL-100 | 100cm | 0,2kg

black and grey



1 2 3 4 5 6

1 PNT-BL-SM | 7,6x7,6x7,6cm | 0,3kg

2 PNT-GY-SM | 7,6x7,6x7,6cm | 0,3kg

1 2 3 4

3 PNT-BL-LA | 18,8x15x14,2cm | 3kg

4 PNT-GY-LA | 18,8x15x14,2cm | 3kg

EN Chalkboard Paint - Water-based acrylic paint for use with chalkmarkers or traditional chalk. Create a chalk wall of any size or paint glass, metal, ceramic, plastic and wood (recommended to use a primer for non-traditional wall surfaces).

FR Peinture Ardoise - Peinture acrylique à base d'eau à utiliser avec des feutres-craie ou des craies traditionnelles. Créez votre propre ardoise sur tout support: Métal, céramique, plastique ou bois. (L'utilisation d'une base pour les surfaces non lisses est recommandée). **DE** Kreidetafel-Farbe - Auf Wasser basierende Acryl-Tafelfarbe für die Verwendung von Kreidestiften oder traditioneller Kreide. Erstellen Sie eine Kreidetafel jeder Größe auf Glas, Metall, Keramik, Kunststoff und Holz (wir empfehlen einen Primer für nichttraditionelle Wandflächen zu verwenden).

IT Pittura Lavagna - Vernice acrilica scrivibile con i pennarelli a gesso liquido ma anche con il classico gessetto. Potrete creare in questo modo una lavagna su misura dalle dimensioni

desiderate o trasformare in lavagna qualsiasi oggetto in vetro, metallo, legno e ceramica (Per superfici e pareti non imbiancate si consiglia prima l'utilizzo del fissativo). **ES** Pintura de Pizarra - Pintura acrílica al agua para usar con rotuladores de pizarra o tiza tradicional. Crea una pared de pizarra de cualquier tamaño, o transformar en pizarra cualquier superficie en cristal, metal, cerámica, plástico y madera (se recomienda usar pintura base para superficies de pared no tradicionales). **PT** Tinta para Quadros - Tinta acrílica à base de água para ser usada com marcadores de giz ou com giz tradicional. Crie uma parede de giz de qualquer tamanho, ou para pintar vidro, metal, cerâmica, plástico e madeira (é recomendado usar um primário para superficies de parede não tradicionais). **CZ** Barva pod Křídové Popisovače - Akrylátová černá barva vhodná na plochy určené pro použití křídových popisovačů nebo kříd. Vytvořte plochu volitelných rozměrů na jakémkoliv materiálu - sklo, kov, keramika, plast a dřevo (doporučujeme na netradiční povrchy).



Self adhesive chalkboard foil



EN Self Adhesive Chalkboards - Suitable for all surfaces.

FR Ardoises Auto-adhésives - À utiliser sur toutes surfaces. **DE** Selbstklebende Kreidetafel - Geeignet für alle Oberflächen. **IT** Lavagne Autoadesive - Adoperabili per qualsiasi superficie. **ES** Pizarras Autoadhesivas - Adecuadas para todas las superficies. **PT** Quadros Adesivos - Adequado para todas as superfícies. **CZ** Nalepovací Popisovací Tabule - Vhodné pro všechny povrchy.

1 12 144 1 CS-OVAL-8 | 8,5x5x0,2cm | 0,026kg 2 CS-RECT-8 | 8,5x5x0,2cm | 0,026kg
1 12 60 3 CS-WALL-100 | 100x45x3,5cm | 0,158kg



Flags

NEW

12PCS - 4MTR

+ Securit CHALKMARKER

EN Chalkboard Flags - String of 12 strong, flexible chalkboard flags with double sided writing surface. Make your own unique designs for all your festive events.

FR Guirlande Drapeau Ardoise - chaîne de 12 drapeau ardoise rigide et flexible avec double-face. Idéal pour exprimer de manière unique et avec style tous les moments festifs.

DE Flaggen - Schnur (4m) mit 12 starken, doch flexiblen Kreidetafel-Flaggen. Beidseitig beschreibbar. Machen Sie Ihr eigenes Design für jeden Anlass. **IT** Festone lavagna - 12

bandierine flessibili e resistenti. Scrivibili su entrambi i lati. Per personalizzare ogni festa con il messaggio più appropriato e stupire con stile. **ES** Banderín pizarra - 12 banderas flexibles y resistentes. Se puede escribir en ambos lados. Para personalizar las fiesta con el mensaje correcto y sorprender con estilo.

PT Bandeiras Securit® - Corda de 12 bandeiras fortes e flexíveis com superfície de escrita dupla face. Faça seus próprios projetos originais para todos seus eventos festivos. **CZ** Popisovatelné vlajčky Securit® pro užití křídových popisovačů - 12 ohebných oboustranně popisovatelných vlajček. Jedná se o atraktivní doplněk pro různé oslavy a podobné události.

1 6 60 FB-FLAG | 400x21x0,2cm | 0,1kg

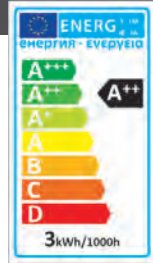
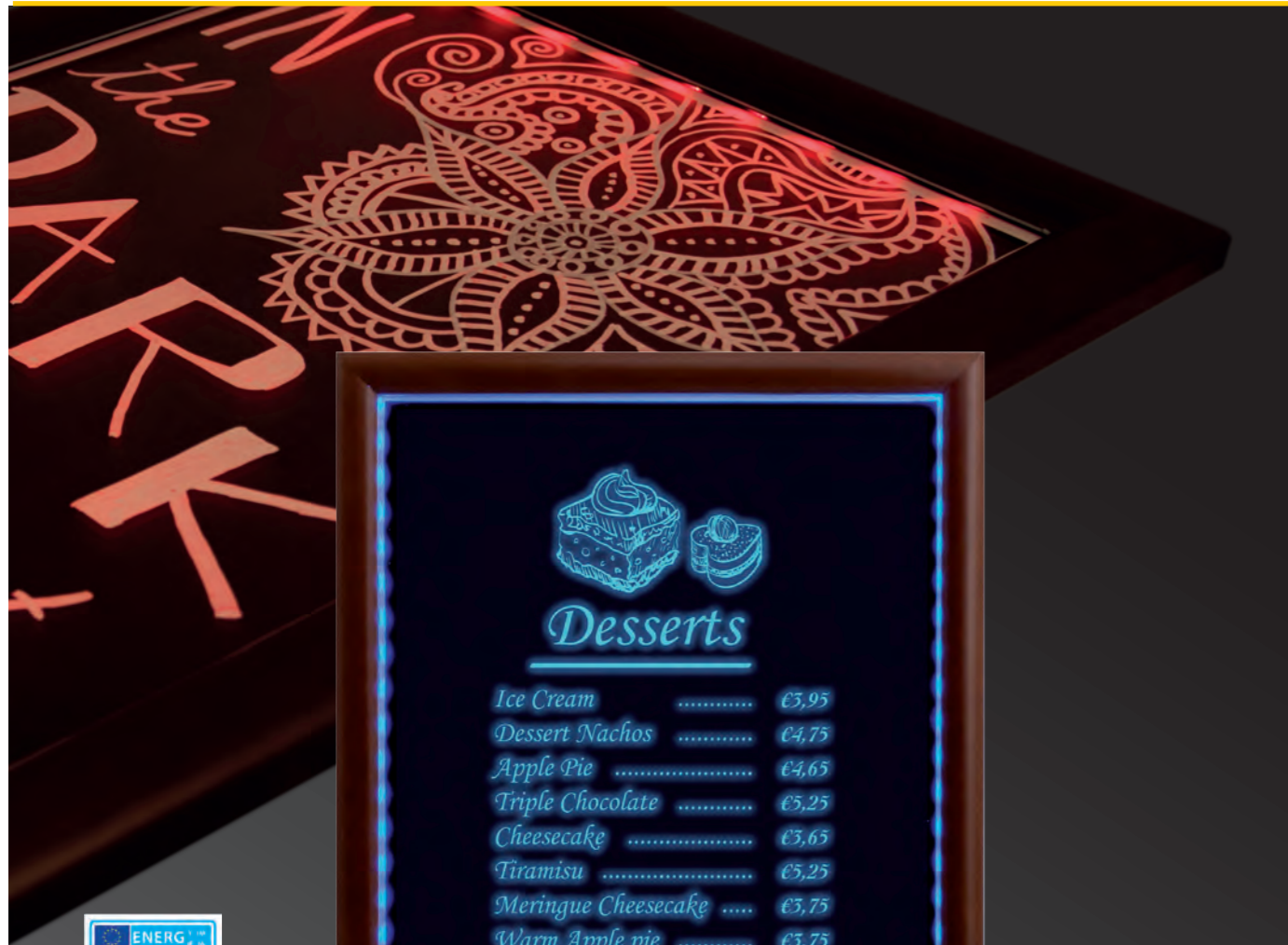

Desserts	
Ice Cream	€3,95
Dessert Nachos	€4,75
Apple Pie	€4,65
Triple Chocolate	€5,25
Cheesecake	€3,65
Tiramisu	€5,25
Meringue Cheesecake	€3,75
Warm Apple pie	€3,75
Sorbet	€6,50
Bananas Foster Pie	€6,25
Chocolate Fondue	€7,25



LED Chalkboard



1 LB-DB-62 | 70x56x7,5cm | 6,8kg 1 24 2 MCS-BATT | 16,5x7,5x1cm | 0,4kg



PNT-BL-SM/
PNT-BL-LA
P.58

FB-CB-HEX
P.54

WBW-TE-30-40
P.48

Securit®
PROMOTES
my
BUSINESS

@SECURIT.NL
#SECURIT_NL

Securit®



Chalk markers
FEUTRES-CRAIE
Kreidemarkers
PENNARELLI A GESSO LIQUIDO
Rotulador de tiza líquida
MARCADORES DE GIZ LIQUIDO
KŘÍDOVÉ POPISOVAČE

EN Liquid Chalkmarkers - Simply shake, push, write and allow drying for a few minutes, then simply wipe clean for a new message or design. For boards, glass, metal or plastic.

FR Feutres-craie à Encre Liquide - Secouez, pressez, écrivez et laissez sécher quelques minutes, ensuite effacez facilement et recommencez. À utiliser sur nos ardoises, du verre, du métal ou du plastique. **DE** Flüssige Kreidemarkers - Einfach schütteln und pumpen um zu schreiben. Ein paar Minuten trocknen lassen. Kann jederzeit wieder abgewischt werden um eine neue Nachricht oder ein neues Design zu schreiben. Perfekt für Tafeln, Glas, Metall und Plastik.

IT Pennarelli a Gesso Liquido - Basterà agitare, pompare il colore sulla punta, scrivere e lasciarlo asciugare. Scrive anche su vetro, plastica, metallo, specchi e si pulisce facilmente con un panno bagnato.

ES Rotuladores de Pizarra Líquidos - Simplemente agita, presiona, escribe y deja unos minutos para que se seque, entonces solo tienes que limpiar para escribir un nuevo mensaje o diseño. Para tablas, cristal, metal o plástico. **PT** Marcadores de Giz Líquido - Apenas abane, pressione, escreva e desenhe por uns minutos, depois uma simples limpeza para uma nova mensagem ou desenho.

Para tábuas, vidro, metal ou plástico. **CZ** Tekuté Křídové Popisovače - Jednoduše protřepejte, stiskněte hrot a pište. Nápis uschne během několika minut. Lze ho jednoduše smazat a psát znovu. Jsou vhodné na tabule, sklo nebo plastové povrchy.

Securit® CHALKMARKER ORIGINAL



GOLD/SILVER



BASIC COLORS

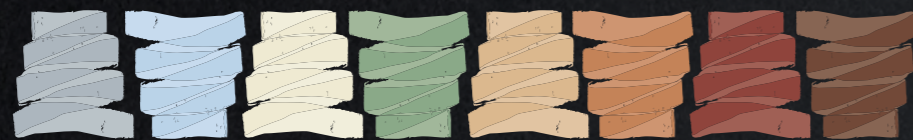

EARTH COLORS

EN Original Chalkmarker - Resistant to smudging (when dry), fading and light rain. Use on all non-porous surfaces, clean with a sponge and water.

FR Feutres-craie Original - Ne coulent pas, ne décolorent pas et résistent à la pluie. À utiliser sur toutes surfaces non-poreuses. Se nettoient avec une éponge et de l'eau. **DE** Original Kreidemarker - Beständig gegen Verschmieren (wenn trocken), Verblassen und leichten Regen. Schreiben Sie auf alle nicht-porösen Oberflächen. Verwenden Sie einen Schwamm und Wasser zum Reinigen.

IT Pennarello a Gesso Liquido Original - Se lasciato asciugare, non svava, non scolorisce

e resiste alla pioggia leggera. Scrive su tutte le superficie non porose si pulisce facilmente con una spugna bagnata. **ES** Rotulador de Pizarra Original - No se corre (cuando está seco), ni se decolora y resistente a lluvia ligera. Escribe en todas las superficies no porosas y se limpia facilmente con una esponja mojada. **PT** Marcador de Giz Original - Escrita resistente (quando seco), não desvanece nem sai com a chuva. Escreve em todas as superficies não porosas e retire com uma esponja molhada. **CZ** Originální Křídové Popisovače - Po uschnutí jsou odolné proti rozmazání, vyblednutí nebo smytí slabým deštěm. Čistí se houbičkou.

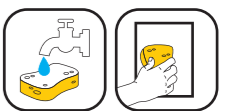



- 1 12 120 1 SMA100-WT, 2 SMA100-GR, 3 SMA100-BU, 4 SMA100-VT, 5 SMA100-PI, 6 SMA100-RD, 7 SMA100-OR, 8 SMA100-YE, 9 SMA100-BL
10 SMA510-GD, 11 SMA510-SL, 12 SMA510-WT, 13 SMA510-GR, 14 SMA510-BU, 15 SMA510-VT,
16 SMA510-PI, 17 SMA510-RD, 18 SMA510-OR, 19 SMA510-YE, 20 SMA510-BL
1 6 60 21 SMA720-WT, 22 SMA720-GR, 23 SMA720-BU, 24 SMA720-VT, 25 SMA720-PI, 26 SMA720-RD, 27 SMA720-OR, 28 SMA720-YE

Securit® CHALKMARKER ORIGINAL



SMA100 

SMA510 

SMA720 



- 1 12 144 1 BL-SMAMIX-V5-WT
- 1 12 144 2 BL-SMA100-V7-WT
- 3 BL-SMA100-V7-AS
- 4 BL-SMA100-V2-WT
- 5 BL-SMA100-V4-WHI
- 6 BL-SMA100-V4-TRO
- 7 BL-SMA100-V4-COL
- 8 BL-SMA100-V2-GDSL

- 1 18 216
- 9 BL-SMA510-WT, 10 BL-SMA510-YE,
- 11 BL-SMA510-OR, 12 BL-SMA510-RD,
- 13 BL-SMA510-PI, 14 BL-SMA510-VT,
- 15 BL-SMA510-BU, 16 BL-SMA510-GR,
- 17 BL-SMA510-GD, 18 BL-SMA510-SL

- 1 12 12
- 19 SMA510-V8-WT
- 20 SMA510-V8
- 21 SMA510-V8-ET
- 22 SMA510-V4-WT
- 23 SMA510-V4

- 1 12 144
- 24 BL-SMA720-WT, 25 BL-SMA720-YE,
- 26 BL-SMA720-OR, 27 BL-SMA720-RD,
- 28 BL-SMA720-PI, 29 BL-SMA720-VT,
- 30 BL-SMA720-BU, 31 BL-SMA720-GR

- 1 6
- 32 SMA720-V8-WT
- 33 SMA720-V8
- 34 SMA720-V8-ET
- 1 12
- 35 SMA720-V4-WT
- 36 SMA720-V4

Securit® waterproof GLASS+ CHALKBOARD+



BASIC COLORS

EN Waterproof, Glass & Chalkboard Marker - Waterproof, smudge-proof and fade-proof (when dry) on all surfaces. Use on all non-porous surfaces, clean with a sponge and Securit® spray cleaner.

FR Feutres-craie Waterproof / Spécial Verre - Feutres-craie Waterproof, ne coulent pas, ne décolorent pas et s'utilisent sur toutes surfaces non-poreuses. À nettoyer avec une éponge et le spray nettoyant Securit®.

DE Wasserfeste Kreidemarker - Wasserfest, wischfest und farbfest auf allen nicht-porösen Oberflächen. Verwenden Sie einen Schwamm und Securit® Reiniger zum Säubern.

IT Pennarelli a Gesso Liquido Resistenti all'Acqua per Vetri e Lavagne - Scritte impermeabili e resistenti su qualsiasi

superficie non porosa. Pulire con una spugna ed il detergente Securit®.

ES Rotulador para Cristal y Pizarra a Prueba de Agua - Resistente al agua, no se corre ni descolora en cualquier superficie. Escribe en todas las superficies no porosas y se limpia fácilmente con una esponja y e limpiador Securit®. **PT** Vidro À Prova de Água e Marcadores para Quadros - À prova de água, à prova de manchas e à prova de desbotação, em todas as superfícies. Escreve em todas as superfícies não porosas e retire com uma esponja e removedor Securit®. **CZ** Voděodolné Křídové Popisovače na Sklo - Odolné proti působení vody, rozmazání a vyblednutí. Čistí se pomocí houbičky a čističe Securit®.

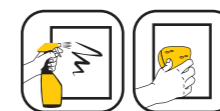

Securit®
waterproof
GLASS
CHALKBOARD+

SMA610



SMA820



ACCESSORIES



- 1 - 12
- 1 SMA610-V4-WT
 - 2 SMA610-V4-BW
 - 3 SMA610-V4
 - 4 SMA610-V2-WT

- 1 - 12
- 5 SMA820-V4-WT
 - 6 SMA820-V4-BW
 - 7 SMA820-V4
 - 8 SMA820-V2-WT

- 1 - 10 - 60
- 9 SECSTN-5 | 37x23,5x1cm | 0,19kg
 - 1 - 12
 - 10 SPONGE-2 | 16,5x11x3cm | 0,033kg
 - 11 SECCLEAN-KL | 500ml | 0,566kg
 - 12 SECCLEAN-GR | 750ml | 0,816kg

NEW WINDOODLE.COM



Window stencils

EN Window stencils - Window art was never this easy! Simply stick one of the designs on the window and recreate that design on the other side by marking the lines with our Securit® Chalkmarker.

FR Pochoirs vitrine (Lot de 3 pochoirs) - L' Art Déco en vitrine plus simple que jamais! Plaquer simplement un modèle de pochoir sur la vitrine en extérieur et recréer le modèle sur la vitrine en intérieur en reproduisant les formes grâce à nos feutres craies Securit® + la gamme Waterproof.

DE Fensterschablone - Fenstermalereien waren noch nie so einfach! Eine der Schablonen einfach von außen an der Scheibe befestigen und die Linien mit unseren wasserfesten Securit® Glas- und Kreidestiften nachziehen. **IT** Stencil DecoVetro - Trasforma qualsiasi vetrata in un'opera d'arte! Basta attaccare uno dei disegni sul lato esterno della finestra e ricalcare le linee del disegno sulla parte interna con i nostri pennarelli a gesso liquido Original e resistenti all'acqua Securit®

ES Plantillas Deco-Vidrio. Transforma cualquier ventana en una obra de arte con nuestras plantillas. Pega las plantillas en la parte exterior de la ventana y traza las líneas y contornos del diseño en el interior con nuestros marcadores de tiza líquida Original y resistentes al agua Securit®. **PT** Stencil para janela - Transforme qualquer janela numa obra de arte com os nossos autocolantes. Coloque o stencil na parte exterior da janela e contorne o desenho os nossos marcadores resistente à água, de tinta líquida Original Securit®. **CZ** Šablony na sklo. Malování na sklo nebylo nikdy tak jednoduché! Jednoduše přichytněte příslušnou šablonu na vnější část skla. Na vnitřní části Vašeho okna podle šablony s pomocí voděodolných nebo standardních křídových popisovačů Securit® vytvořte příslušné obrazy.

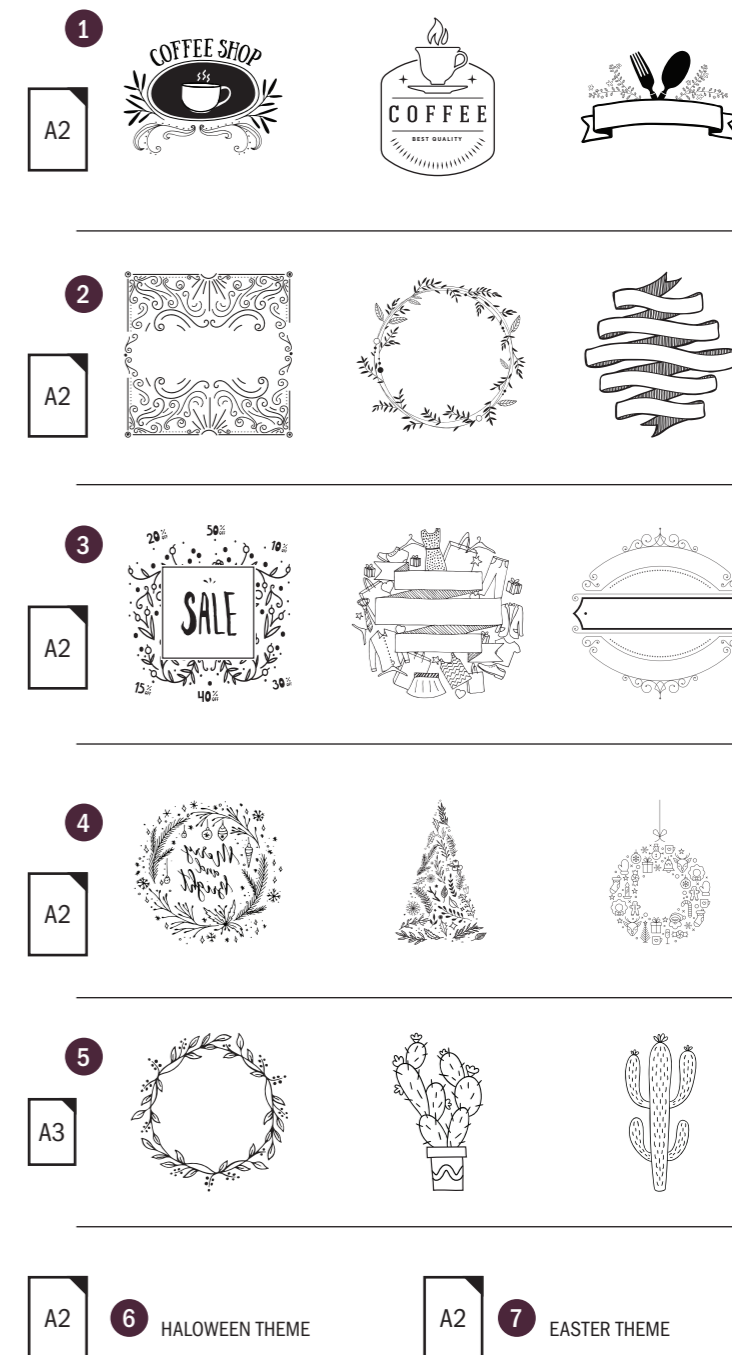

3 | 6 | 60

1 WD-3A2-FD | 42x59,4cm | 0.05kg

2 WD-3A2-SG | 42x59,4cm | 0.05kg

3 WD-3A2-SP | 42x59,4cm | 0.05kg

4 WD-3A2-XM | 42x59,4cm | 0.05kg

5 WD-3A3-PL | 29,7x42cm | 0.05kg

6 WD-3A2-HL | 42x59,4cm | 0.05kg

7 WD-3A2-ES | 42x59,4cm | 0.05kg





CHALK SPRAY ORIGINAL

EN Chalk Spray - Simply shake and push to spray; allow drying, then simply wipe clean for a new message or design. For boards, glass, mirror, ceramic, metal or plastic. Use on all surfaces and clean with a sponge and water.



FR Pulvérisateur Spray feutre craie-simple d' utilisation, remuer et appuyer pour pulvériser; laisser sécher et essuyer simplement pour effacer et mettre de nouveau message ou design. S' utilise sur toutes les surfaces ardoise, vitre, miroir, céramique, métal ou plastique. Se nettoie facilement à l' eau avec une éponge. **DE** Kreidespray - einfach schütteln, sprühen, trocknen lassen. Kann weggewischt werden um dann ein neues Bild zu sprühen. Für alle nicht porösen Oberflächen wie Tafeln, Glas, Spiegel, Keramik, Metall oder Plastik. Einfach mit einem Schwamm und Wasser zu entfernen.

IT Pittura Spray per Murali / Decorazioni Ecologiche - Facile da usare, basta agitare, spruzzare e aspettare che si asciughi. Si pulisce facilmente con dell'acqua e la superficie sarà pronta per essere nuovamente decorata. Adatta ad ogni superficie: lavagne, vetro, ceramica, metallo o plastica. **ES** Pintura Spray - Para murales / decoraciones ecológicas. Fácil de usar, sólo tiene que agitar, rociar y esperar a que se seque. Se limpia fácilmente con agua y la superficie estará lista para seguir decorando. Se adapta a cualquier superficie: pizarras, vidrio, cerámica, metal o plástico. **PT** Stencil para janela - Transforme qualquer janela numa obra de arte com os nossos autocolantes. Coloque o stencil na parte exterior da janela e contorne o desenho os nossos marcadores de tinta líquida Original e resistente à água Securit®. **CZ** Křídový sprej - jednoduše zatřepějte a stiskněte čepičku. Nechte zaschnout. Jednoduše setřete a plocha je připravena pro novou zprávu. Vhodný pro tabule, sklo, zrcadla, keramiku, kov nebo plast. Použijte na všechny tyto povrchy a čistěte pomocí houbičky a vody.



MENU HOLDERS

MC-TRA4-BL
P.86

MC-TRA4-LB
P.87

PROTÈGE-MENUS
MENÜKARTEN
PORTAMENÙ
PORTA-CARTAS
PORTA MENÙ
JÍDELNÍ LÍSTKY

MC-DBBP-BL
P.83

MC-DBBP-GY
P.83

MC-DBBP-GY
P.83



Leather range



EN Eco leather Menu Holders - Flexible and easy to clean bonded leather menu with a metal plate.

FR Protège-menu cuir eco - Flexible et facile à nettoyer grâce à son cuir écologique- munit d' une plaque en métal sur la couverture en cuir.

DE Menümappe aus Öko Leder mit

Edelstahlplatte - flexibel und leicht zu reinigen. **IT** Portamenu in Pelle - realizzato con pelle ecologica, flessibile e facile da pulire. La placca di metallo stampata lo rende il massimo dell'eleganza. **ES** Porta menús Línea Cuero - Realizados con cuero ecológico, flexible y fácil de limpiar. La placa metálica impresa aporta un máximo de elegancia. **PT** Menu

linha Couro - menu em couro ecológico, flexível e fácil de limpar. A placa de metal impressa acrescenta-lhe elegância. **CZ** Desky na jídelní lístky eko kůže - pružný a lehce čistitelný jídelní lístek vyrobený z lepené kůže, s kovovým štítkem.

NEW



ROYAL

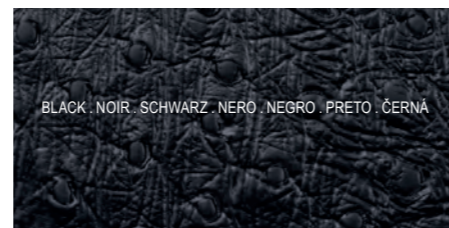
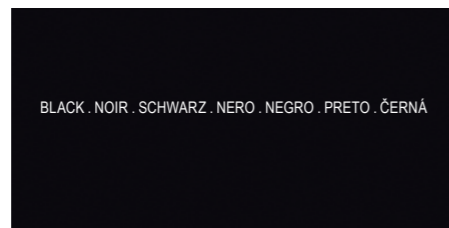
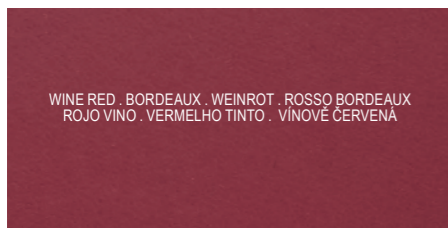

1 10 - 1 MC-LRA4-RORD | 33x24cm | 0.255kg 2 MC-LRA4-ROBL | 33x24cm | 0.255kg 3 MC-LRA4-EGBL | 33x24cm | 0.255kg

EGO

RAW

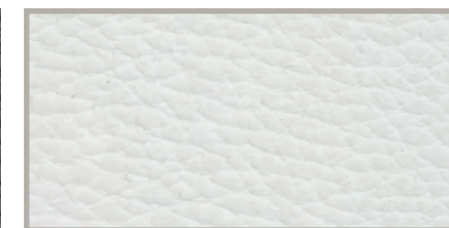
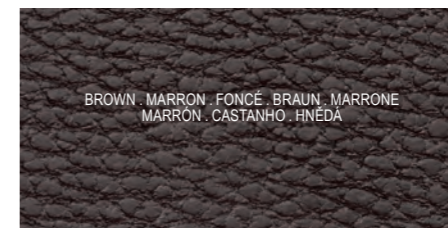
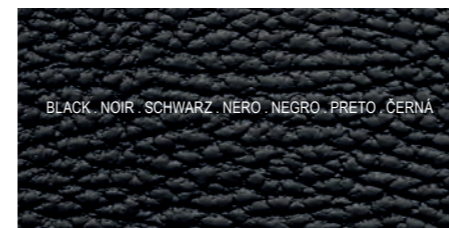

1 10 - 4 MC-LRA4-RWBL | 33x24cm | 0.255kg 5 MC-LRA4-RWBR | 33x24cm | 0.255kg 6 MC-LRA4-RWWT | 33x24cm | 0.255kg
1 10 40 7 MC-LRPM-RWBL | 33x45cm | 0.232kg

EN every menu holder includes one extra loose metal plate for custom printing. **IT** All'interno di ogni menu è compresa una targhetta di metallo neutra (in più) da personalizzare con il proprio nome o logo. **ES** Dentro de cada menú hay una placa metálica neutra (extra) para la personalización con su nombre o logotipo. **PT** Dentro de cada menu é uma placa de metal neutro (extra) para personalizar com seu nome ou logotipo. **DE** Mit jeder Menükarte wird eine blanke Edelstahlplatte geliefert, worauf Sie selbst Ihr Logo gravieren lassen können.





Bill presenter

EN Bill Presenter - Leather style bill presenter with wooden coin holder and elastic band.

FR Porte Addition - Matière de la couverture en cuir écologique sur un support en bois pour la collection des pièces de monnaie ou billet et une fermeture par le biais d' un élastique.

DE Rechnungsmappe - aus echtem Leder mit hölzernem Münzfach und Gummiband.

IT Portaconto - in similpelle con base in legno scavata porta monete e chiusura elastica.

ES Porta cuenta - semicuero con bandeja porta monedas en madera y cierre elástico lateral. **PT** Porta conta - Em silmultâneo com bandeja porta moedas em madeira e banda elástica. **CZ** Desky na účtenku - vyrobeny z kůže se schránkou na mince z masivního dřeva, s elastickým kordem.



NEW
1

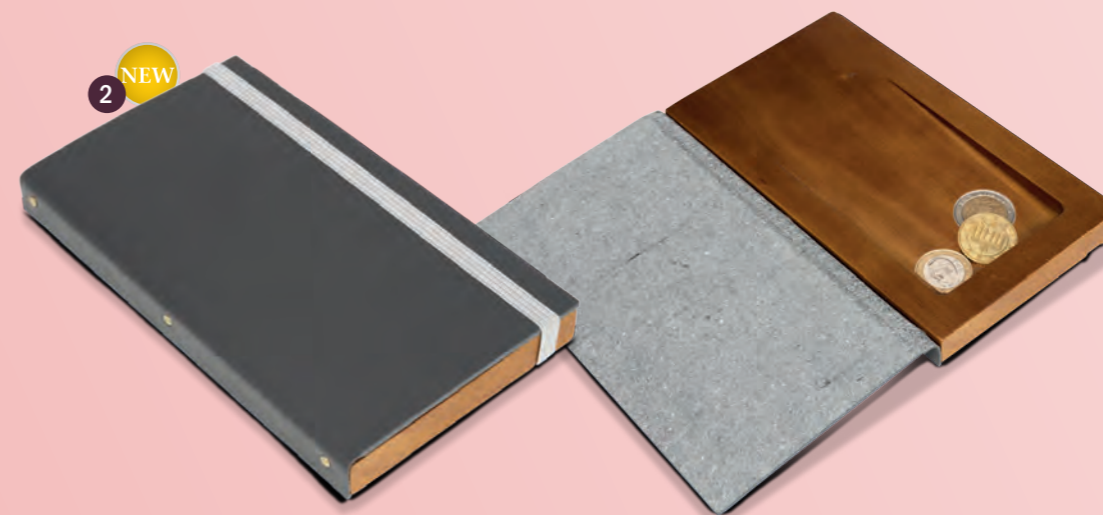

NEW
2



1 6 60 1 MC-DBBP-BL | 17,9x10x1,8cm | 0.1kg 2 MC-DBBP-GY | 17,9x10x1,8cm | 0.1kg



Classic

EN Classic Menu Holders - Leather style menu holder with gold printed 'menu' text, metal corner protectors and stitched edges.

FR Protège-menus Classic - Couverture en imitation cuir, inscription 'menu' en lettres dorées, coins de protection en métal et bords cousus. **DE** Menükarte "Classic" - in Lederoptik und Gold gedrucktem Text 'Menu'. Mit Metallschutzecken und genähten Kanten. **IT** Portamenù Linea Classic - Realizzati in similpelle con la scritta dorata 'menu'. Angoli protettivi in metallo e bordi rifiniti. **ES** Porta menús Linea Classic - Porta-cartas clásicos en simil cuero con el texto 'menu' impreso en oro, esquinas reforzadas en metal y bordes cosidos. **PT** Suportes de Menu Clássicos - Suporte para Menu de efeito Pele com uma inscrição em dourado de texto a dizer 'menu', protetores de cantos em metal e bordas costuradas. **CZ** Jídelní Lístky Classic - Povrchová úprava stylu kůže, zlatý nápis 'menu', kovové růžky a prošivané hrany.

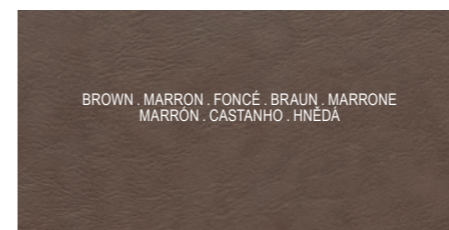
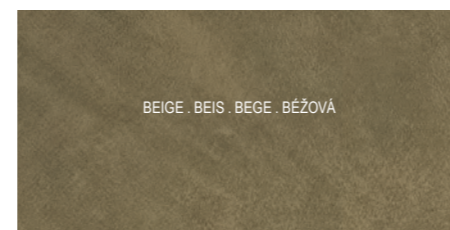
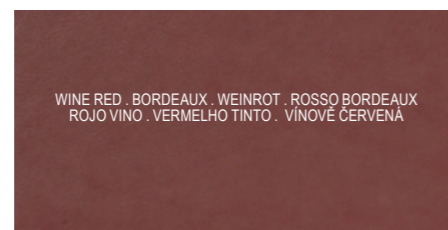
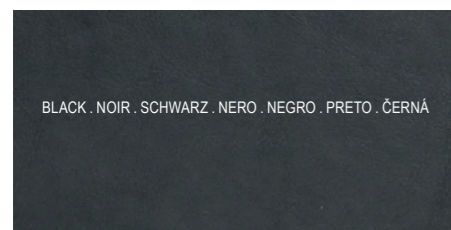
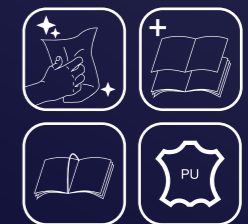

- 1 - 2
- 1 MC-BOX-CRA4-BL | 25x28x30,5cm | 10,6kg
- 1 10 40
- 2 MC-CRA4-BL | 34,5x24,5x1cm | 0,332kg
- 3 MC-CRWC-BL | 34x24x1cm | 0,35kg
- 4 MC-CRA5-BL | 19x16x1cm | 0,145kg
- 5 END MC-CR45-BL | 36x19x1cm | 0,27kg
- 6 MC-CRBP-BL | 23x14x1cm | 0,113kg

- 1 - 2
- 1 END MC-BOX-CRA4-WR | 25x28x30,5cm | 10,6kg
- 1 10 40
- 2 MC-CRA4-WR | 34,5x24,5x1cm | 0,332kg
- 4 MC-CRA5-WR | 19x16x1cm | 0,145kg
- 5 END MC-CR45-WR | 36x19x1cm | 0,27kg

- 1 10 40
- 2 END MC-CRA4-BI | 34,5x24,5x1cm | 0,332kg
- 4 END MC-CRA5-BI | 19x16x1cm | 0,145kg

- 1 - 2
- 1 END MC-BOX-CRA4-BR | 25x28x30,5cm | 10,6kg
- 1 10 40
- 2 MC-CRA4-BR | 34,5x24,5x1cm | 0,332kg
- 4 MC-CRA5-BR | 19x16x1cm | 0,145kg

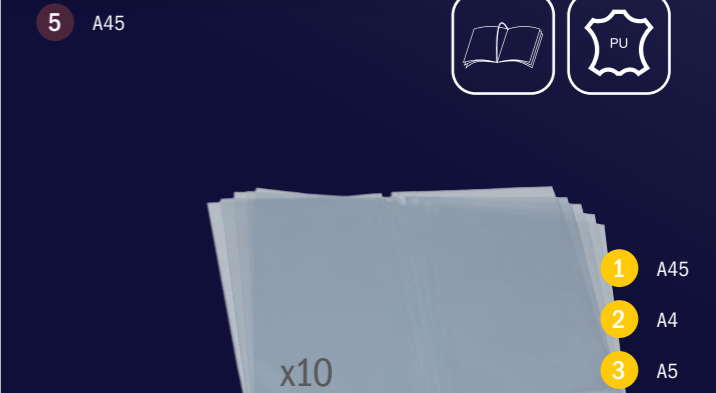

- 1 10 - 1 MC-TI45 | 29,8x14,8x1cm | 0,24kg
- 1 20 80 2 MC-TIA4 | 29,7x21x1cm | 0,323kg
- 1 20 100 3 MC-TIA5 | 21x14,8x1cm | 0,178kg

Trendy



EN Trendy Menu Holders - Leather style menu holder with embossed 'menu' text and stitched edges.

FR Protège-menus Tendance - Couverture en simili cuir, inscription 'menu' en relief et bords cousus. **DE** Menükarte "Trendy" - in Lederoptik und Gold gedrucktem Text 'Menu'. Mit genähten Kanten. **IT** Portamenù Linea Trendy - Realizzati in

similpelle con la scritta stampata a rilievo 'menu' e bordi rifiniti. **ES** Porta Menús Línea Trendy - Porta-cartas a la moda en simil cuero. Texto 'menu' en relieve y bordes cosidos. **PT** Suportes para Menus Modernos - Suportes para Menus efeito Pele. Com texto 'menu' embutido e bordas costuradas. **CZ** Jídelní Lístky Trendy - Porchová úprava stylu kůže, povrchová úprava 'menu' a prošivané hrany.

2 A4

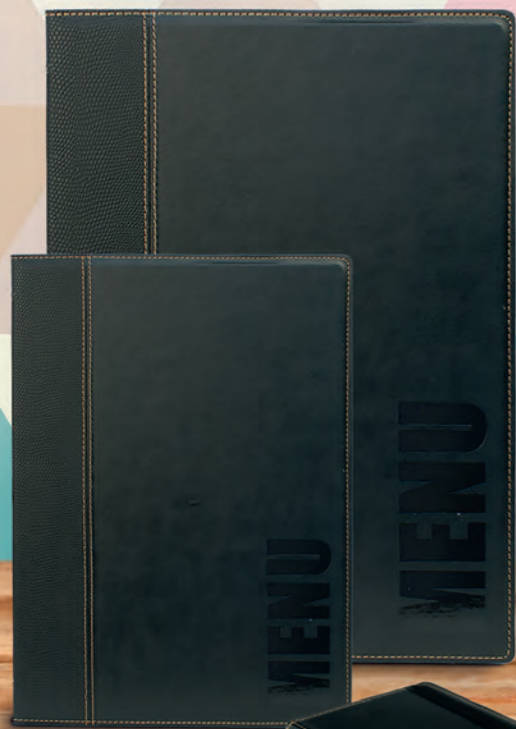

4 A5



5 A45



Box x20 menus 1



3 Wine card



6 Bill Presenter

7 Bill Presenter wood

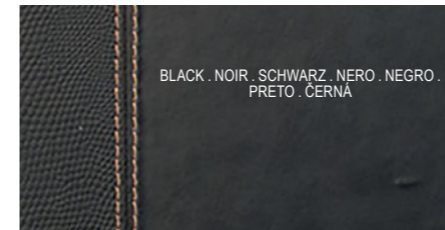

- 1 1 2
- 1 MC-BOX-TRA4-BL | 25x28x32cm | 8,7kg
- 1 10 40
- 2 MC-TRA4-BL | 34x25x1cm | 0,365kg
- 3 MC-TRWC-BL | 34,5x25x1cm | 0,365kg
- 4 MC-TRA5-BL | 25x19x1cm | 0,175kg
- 5 MC-TR45-BL | 35x18,5x1cm | 0,28kg
- 6 MC-TRBP-BL | 24x13,5x1cm | 0,11kg
- 1 6 60
- 7 MC-DBBP-BL | 17,9x10x1,8cm | 0,1kg

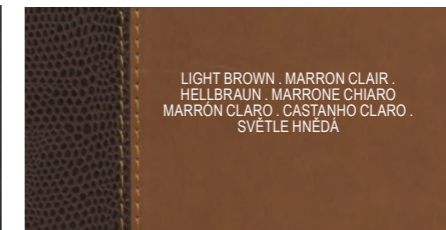

- 1 1 2
- 1 MC-BOX-TRA4-LB | 25x28x32cm | 8,7kg
- 1 10 40
- 2 MC-TRA4-LB | 34x25x1cm | 0,365kg
- 4 MC-TRA5-LB | 25x19x1cm | 0,175kg
- 5 MC-TR45-LB | 35x18,5x1cm | 0,28kg

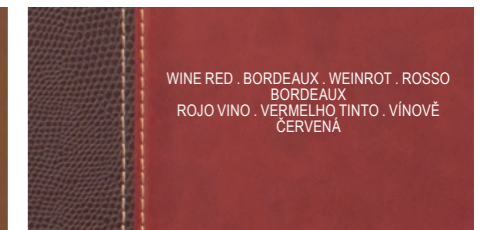

- 1 1 2
- 1 MC-BOX-TRA4-WR | 25x28x32cm | 8,7kg
- 1 10 40
- 2 MC-TRA4-WR | 34x25x1cm | 0,365kg
- 4 MC-TRA5-WR | 25x19x1cm | 0,175kg
- 5 MC-TR45-WR | 35x18,5x1cm | 0,28kg



- 1 1 2
- 1 MC-BOX-TRA4-GR | 25x28x32cm | 8,7kg
- 1 10 40
- 2 MC-TRA4-GR | 34x25x1cm | 0,365kg
- 4 MC-TRA5-GR | 25x19x1cm | 0,175kg

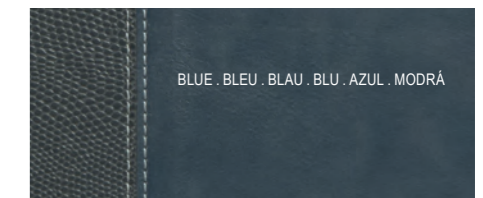

- 1 1 2
- 1 MC-BOX-TRA4-BU | 25x28x32cm | 8,7kg
- 1 10 40
- 2 MC-TRA4-BU | 34x25x1cm | 0,365kg
- 4 MC-TRA5-BU | 25x19x1cm | 0,175kg



- 1 10 -
- 1 20 80
- 1 20 100
- 1 MC-TI45 | 29,8x14,8x1cm | 0,24kg
- 2 MC-TIA4 | 29,7x21x1cm | 0,323kg
- 3 MC-TIA5 | 21x14,8x1cm | 0,178kg

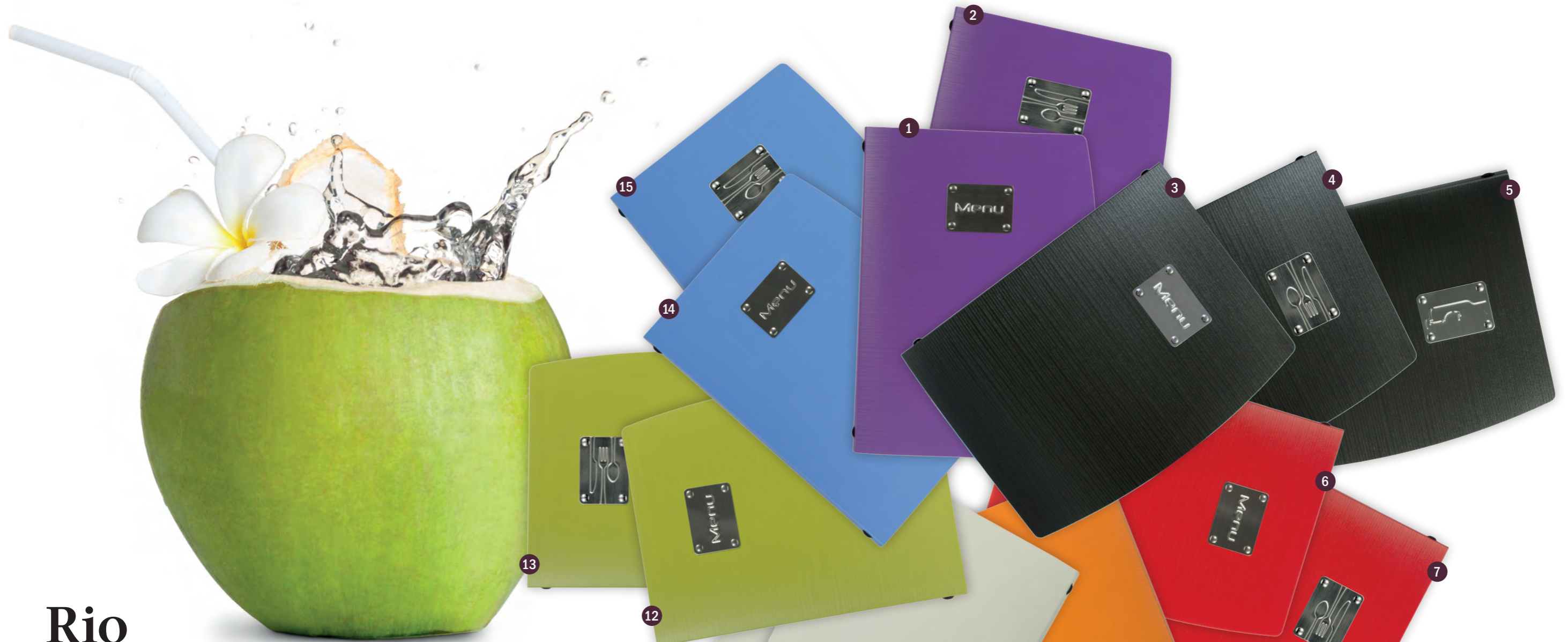

Rio

EN Rio Menu Holders - Flexible and easy to clean Poly Prop. menu with a stamped stainless steel plate.

FR Protège-menus Rio - Couverture plastique flexible et facile à nettoyer avec plaque "Menu" en inox intégrée. **DE** "Rio" - elastisch, einfach zu reinigen. Mit gestanzter Edelstahlplatte auf der Vorderseite. **IT** Portamenù Linea Rio - Flessibili, colorati, resistenti e facili da pulire. Polipropilene arricchito da un'etichetta serigrafata in acciaio inox.

ES Porta Menús Linea Rio - Menú en polipropileno flexible y fácil de limpiar con placa de acero inoxidable estampada. **PT** Suportes de Listas de Menus - Menu de plástico flexível e fácil de limpar com uma placa de aço inoxidável estampada.

CZ Jídelní Lístky Rio - Pružné plastové omyvatelné desky se štítkem z nerezové oceli.



1 20 80

MC-TIA4 | 29,7x21x1cm | 0,323kg



1 10 40

1 MC-RCA4-VT | 34x25x1,5cm | 0,215kg 2 MC-RCA4-VT-FK | 34x25x1,5cm | 0,215kg 3 MC-RCA4-BL | 34x25x1,5cm | 0,215kg 4 MC-RCA4-BL-FK | 34x25x1,5cm | 0,215kg 5 MC-RCWC-BL | 34x25x1,5cm | 0,215kg 6 MC-RCA4-RD | 34x25x1,5cm | 0,215kg 7 MC-RCA4-RD-FK | 34x25x1,5cm | 0,215kg 8 MC-RCA4-OR | 34x25x1,5cm | 0,215kg 9 MC-RCA4-OR-FK | 34x25x1,5cm | 0,215kg 10 MC-RCA4-WT | 34x25x1,5cm | 0,215kg 11 MC-RCA4-WT-FK | 34x25x1,5cm | 0,215kg 12 MC-RCA4-GR | 34x25x1,5cm | 0,215kg 13 MC-RCA4-GR-FK | 34x25x1,5cm | 0,215kg 14 MC-RCA4-BU | 34x25x1,5cm | 0,215kg 15 MC-RCA4-BU-FK | 34x25x1,5cm | 0,215kg

Wood

EN Wood Menu Holders - Solid wooden spine menu holders, with anti-reflective frosted inserts.

FR Protège-menus Bois - Bordures en bois et inserts anti-reflets. **DE** Holzmenükarten - Hartholz Menükarten mit Anti-Reflex-beschichtetem Sichtfenster. **IT** Portamenù in Legno - Un menù resistente grazie anche al supporto laterale in legno ed agli inserti antiriflesso con effetto satinato. **ES** Porta Menús de Madera - Menús de madera sólida con piezas mate antireflectantes.

PT Suportes para Menus de Madeira - Menus de madeira sólidos com inserções foscas. **CZ** Jídelní Listky Wood - Mají hřbet z masivního dřeva a vložky s antireflexní úpravou.



1 Box x20 menus

2 A4

5 A5

4 A5 inserts

A4 inserts 3

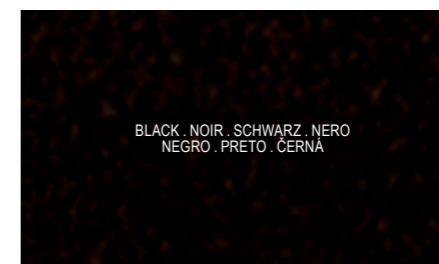
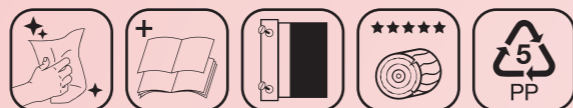

- 1
- 1 MC-BOX-WRA4-BL | 35x27x35cm | 7,4kg
- 1
- 2 MC-WRA4-BL | 32x26x2cm | 0,24kg
- 3 MC-WIA4-BL | 32x26x1cm | 0,42kg
- 4 MC-WIA5-BL | 24x21x1cm | 0,25kg
- 1
- 5 MC-WRA5-BL | 24x21x2cm | 0,16kg



- 1
- 1 MC-BOX-WRA4-WR | 35x27x35cm | 7,4kg
- 1
- 2 MC-WRA4-WR | 32x26x2cm | 0,24kg
- 3 MC-WIA4-WR | 32x26x1cm | 0,42kg
- 4 MC-WIA5-WR | 24x21x1cm | 0,25kg
- 1
- 5 MC-WRA5-WR | 24x21x2cm | 0,16kg



- 1
- 1 MC-BOX-WRA4-BR | 35x27x35cm | 7,4kg
- 1
- 2 MC-WRA4-BR | 32x26x2cm | 0,24kg
- 3 MC-WIA4-BR | 32x26x1cm | 0,42kg
- 4 MC-WIA5-BR | 24x21x1cm | 0,25kg
- 1
- 5 MC-WRA5-BR | 24x21x2cm | 0,16kg



- 1
- 2 MC-WRA4-GR | 32x26x2cm | 0,24kg
- 3 MC-WIA4-GR | 32x26x1cm | 0,42kg
- 4 MC-WIA5-GR | 24x21x1cm | 0,25kg
- 1
- 5 MC-WRA5-GR | 24x21x2cm | 0,16kg



- 1
- 2 MC-WRA4-BU | 32x26x2cm | 0,24kg
- 3 MC-WIA4-BU | 32x26x1cm | 0,42kg
- 4 MC-WIA5-BU | 24x21x1cm | 0,25kg
- 1
- 5 MC-WRA5-BU | 24x21x2cm | 0,16kg



- 1
- 2 MC-WRA4-BI | 32x26x2cm | 0,24kg
- 3 MC-WIA4-BI | 32x26x1cm | 0,42kg
- 4 MC-WIA5-BI | 24x21x1cm | 0,25kg
- 1
- 5 MC-WRA5-BI | 24x21x2cm | 0,16kg



Basic

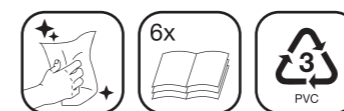

EN Basic Menu Holders - Gloss leather style menu holder with gold print and metal corners.

FR Protège-menus Basic - Couverture en simili cuir, inscription en lettres dorées et coins de protection en métal. **DE** Menükarten "Basic" - Menükarte in Glanzlederoptik mit Golddrucktext und Metallschutzecken. **IT** Portamenù Basic - Un menù in stile pelle lucente con la scritta 'menu' in oro stampato. **Angoli protettivi**

in metallo.

ES Porta Menús Línea

Basic - Porta menús de estilo de cuero brillante con impresión de oro y esquinas de metal.

PT Suportes Para Menus Sólidos - Suportes para Menus efeito Pele com cantos de metal e inscrições douradas. **CZ** Jídelní Lístky Basic - Povrchová úprava ve stylu hladké kůže, se zlatým nápisem a kovovými rúžky.

1 10 40 1 MC-BRA4-BL | 32x22x1cm | 0,465kg 2 MC-BRWC-BL | 32x22x1cm | 0,465kg 3 MC-BRA5-BL | 23x16x1cm | 0,25kg
4 MC-BRBP-BL | 23x13x1cm | 0,232kg 1 - 2 5 MC-BOX-BRA4-BL | 25x28x30,5cm | 10,6kg

1 10 40 6 MC-BRA4-WR | 32x22x1cm | 0,465kg 7 MC-BRA5-WR | 23x16x1cm | 0,25kg
1 - 2 8 MC-BOX-BRA4-WR | 25x28x30,5cm | 10,6kg



Securit®

SHOWS
my MENU

👍 @SECURIT.NL

🐦 📷 📱 #SECURIT_NL

Clip board



EN Clipboard Menu Holders - Rigid wood style surface with a strong stainless steel spring clip.

FR Protège-menus à Pince - Surface en bois et pince en inox. **DE** Klembrett Menükarte - in Holzoptik mit starker Edelstahlklammer. **IT** Portamenù con Clip - Un menù solido in legno con una clip a molla in acciaio inox. **ES** Porta Menús con Pinza - Superficie de estilo de madera rugosa con una robusta pinza de muelle de acero inoxidable. **PT** Placas com Mola de Suporte para Menus - Superfície de madeira com mola de aço inoxidável. **CZ** Jídelní Listky Clipboard - Povrchová úprava rýhované dřevu, s masivní sponou z nerezové oceli.



1 6 40 1 MC-CBA4-BR | 34x23x4cm | 0,312kg 1 10 40 2 MC-CBBP-BR | 26,5x11,4x3cm | 0,11kg

Magnetic menu holder

EN Magnetic Menu Holders – Leather style menu holders, with magnetic sides to securely hold inserts.

FR Protège-menus Magnétique - Surface en simili cuir aux bords magnétiques pour maintenir votre menu en toute sécurité. **DE** Magnetische Menükarten - magnetische Seiten um Einsätze festzuhalten, in Lederoptik. **IT** Portamenù Magnetico - Realizzato in similpelle con parti magnetiche per sostenere saldamente il menù. **ES** Porta Menús Magnéticos - Porta menús de estilo de cuero con con lados magnéticos para mantener de forma segura las piezas. **PT** Suportes para Menu Magnéticos - Suportes para Menu de efeito Pele com lados magnéticos agarrar inserções com segurança. **CZ** Jídelní Listky Magnetic - Povrchová úprava stylu kůže s magnetickými boky pro uchycení vložek.

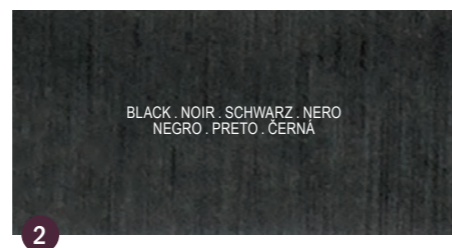
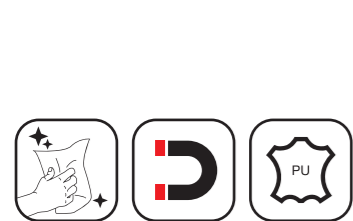

1 10 40 1 MC-MGA4-BR | 33x21,5x0,5cm | 0,25kg 2 MC-MGA4-BL | 33x21,5x0,5cm | 0,25kg

Crystal

EN Crystal Menu Holders - Transparent, anti-reflective double sided menu holders.

FR Protège-menus Crystal - Protège-menus double-face transparents et anti-reflets. **DE** Menükarten "Christal"- Transparent, anti-reflektierend, doppelseitig. **IT** Portamenù Linea Crystal - Trasparenti, antiriflesso ed utilizzabili da entrambi i lati. **ES** Porta Menú Crystal - Menú transparentes, antireflectantes de dobles cara. **PT** Suportes para Menus Cristalinos - Suportes de menus bilaterais, transparentes e anti-reflexos. **CZ** Jídelní Listky Crystal - Průhledné oboustranné desky s antireflexní úpravou.

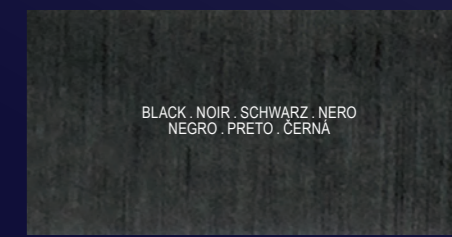
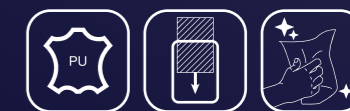
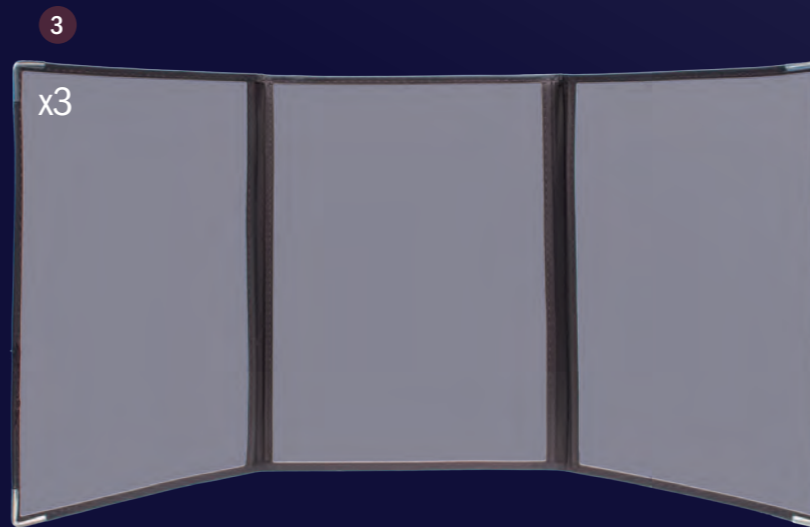

3 16 40 1 MC3-CYA4-BR2 | 37,5x27x2cm | 0,5kg 2 MC3-CYA4-BR1 | 39x26x1cm | 0,28kg 3 MC3-CYA4-BR3 | 38x26x2,3cm | 0,729kg



Design

EN Design Menu Holders - Exclusive design leather style menu holders.

FR Protège-menus Design - Protège-menus très design en simili cuir.

DE Menükarten "Design" - in Lederoptik. **IT** Portamenù Design - Motivi unici ed eleganti. Similpelle.

ES Porta menús línea Deisgn - Porta menús con exclusivo diseño, estilo cuero. **PT** Design de Suportes para Menus - Suportes para Menus de design exclusivo de efeito pele.

CZ Jídelní Lístky Design - Luxusní provedení s povrchovou úpravou ve stylu kůže.



1 10 40 1 MC-TI45 | 29,8x14,8x1cm | 0,24kg
1 20 80 2 MC-TIA4 | 29,7x21x1cm | 0,323kg



1 10 40 1 MC-DRA4-CORK | 34,5x24,5x1cm | 0,47kg 2 MC-DRA4-PAISLEY | 35x27x1cm | 0,49kg
3 MC-DRWC-CORK | 34,2x24,7x1cm | 0,497kg 4 MC-DRA4-WOOD | 35x27x1cm | 0,49kg 5 MC-DRA4-DUNE | 35x27x1cm | 0,49kg
1 2 6 MC-BOX-DRA4-CORK | 41x16x28cm | 6kg 7 MC-BOX-DRA4-PAISLEY | 41x17x28cm | 6,6kg 8 MC-BOX-DRWC-CORK | 41x31,5x18,5cm | 6,5kg

1 10 40 9 MC-DRA4-CROC | 34,2x24,7x1,2cm | 0,56kg 10 END MC-DR45-CROC | 35x18x1,5cm | 0,44kg
11 END MC-TRA4-WT | 34x25x1cm | 0,365kg 12 END MC-TRBC-WT | 35x18x1cm | 0,29kg
13 MC-DRA4-VELVET | 35x27x1cm | 0,49kg 14 MC-DRWC-VELVET | 36x26x1cm | 0,39kg



LED



EN LED Rechargeable Menu Holders - Leather effect menu holders that automatically illuminates the inserts when opened.

FR Protège-menus LED - Protège-menus effet cuir, s'éclaircit automatiquement à l'ouverture.
DE Menükarten "LED" - wiederaufladbar, in Lederoptik. Beleuchtet beim Öffnen automatisch die Einsätze.
IT Portamenù a LED - Menu in similpelle che si illumina automaticamente

all'apertura con una batteria al litio ricaricabile.
ES Porta Menús de LED Recargables - Porta menús con efecto cuero que se ilumina automáticamente al abrirlo.
PT Suportes para Menus com LED Recarregável - Suportes para menus de efeito de pele que iluminam inserções automaticamente quando abertos.
CZ Jídelní listky LED s Dobíjením - Zobrazované plochy se při rozevření automaticky rozsvítí.



1 6 30
4 MC-LD-MC10 | 15x4x3 | 0,3kg



COPPER . CUIVRE . KUPFER . RAME
COBRE . MEDENA

1 - 3
1 MC-LDA4-CP | 35x27x2cm | 1,6kg
2 MC-LD45-CP | 35x19x2cm | 1,06kg
3 END MC-LDSP-CP | 35x27x1cm | 1,06kg



20 6 30
5 MC-LIA4-IJ | A4 | 0,34kg
6 MC-LIA4-LJ | A4 | 0,34kg



BLACK . NOIR . SCHWARZ . NERO
NEGRO . PRETO . ČERNA

1 - 3
1 MC-LDA4-BL | 35x27x2cm | 1,6kg
2 MC-LD45-BL | 35x19x2cm | 1,06kg
3 END MC-LDSP-BL | 35x27x1cm | 1,06kg



SILVER . ARGENT . SILBER . ARGENTO
PLATA . PRATEADO . STRIBRNA

1 - 3
1 MC-LDA4-SL | 35x27x2cm | 1,6kg
2 MC-LD45-SL | 35x19x2cm | 1,06kg
3 END MC-LDSP-SL | 35x27x1cm | 1,06kg

POSTER FRAMES & SIGNS



SI-SS-SET
P.108



PFT-ACL-A5
P.107

PORTE-AFFICHES

PLAKATDISPLAY

PORTA POSTER

PORTA CARTELES

MOLDURAS PARA PÓSTERS

PLAKÁTOVÉ RÁMY



Chalkboard & poster frames

EN Window Displays - Double sided chalkboard or poster display with four suction cups.

FR Porte-affiches et Ardoises à Ventouses - Ardoises et porte-affiches double face dotées de 4 ventouses. **DE** doppelseitiges Fenster Display - Saugnäpfe ermöglichen eine schnelle Repositionierung. **IT** Espositori con Ventose - Una lavagna o un porta poster con quattro ventose. Utilizzabili da entrambi i lati. **ES** Escaparates - Pizarra de dobles cara o marco porta posters con ventosas. **PT** Montras - Quadro de dupla face o molduras para pôsters com ventosas. **CZ** Tabulky na Sklo - Oboustranné popisovací tabulky a plastové rámečky na sklo s přísavkami.



Window Chalkboard

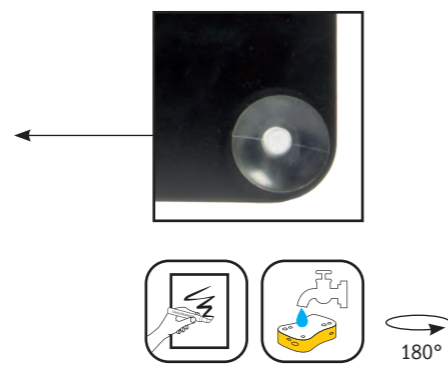

1 6 36 PFW-27-36-BL | 36x27x1,8cm | 0,25kg

Window Poster Frames

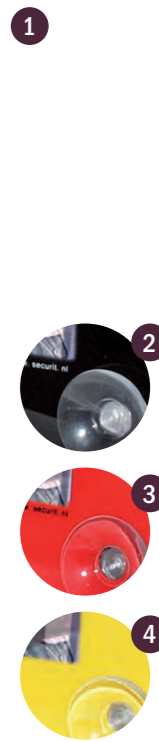
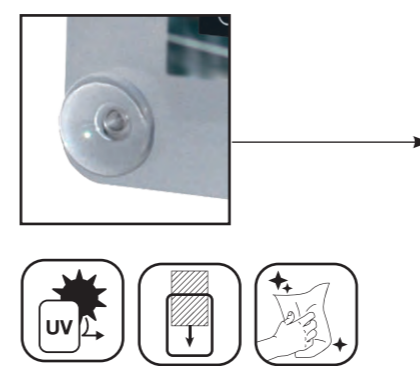

1 6 24 1 PFW-A4-GY, 2 PFW-A4-BL, 3 END PFW-A4-RD, 4 END PFW-A4-YE | 36x27x2cm (A4) | 0,458kg
 1 6 6 1 PFW-A3-GY, 2 PFW-A3-BL, 3 END PFW-A3-RD, 4 END PFW-A3-YE | 52x39x1cm (A3) | 0,9kg



Table poster frames

EN Table Poster Frames - Transparent double sided poster frames that sit securely on any surface.

FR Portes Affiches de Table munis d'un insert transparents permettant d'afficher toute information utile facilement.

DE Tisch Posterdisplay - doppelseitige, transparente Halterung, für Ihre Einlagen. **IT** Porta Poster da Tavola - Sono trasparenti, utilizzabili da entrambi i lati e posizionabili praticamente

ovunque per una comunicazione sicura ed efficace.

ES Marcos para Carteles de Mesa - Marcos para carteles de doble cara transparentes para que se mantengan de forma segura en cualquier superficie. **PT** Molduras de Poster de Mesas - Molduras de Poster transparentes e bilaterais que assentam em qualquer superfície. **CZ** Oboustranné Plakátové Rámy - K umístění na jakýkoliv povrch.

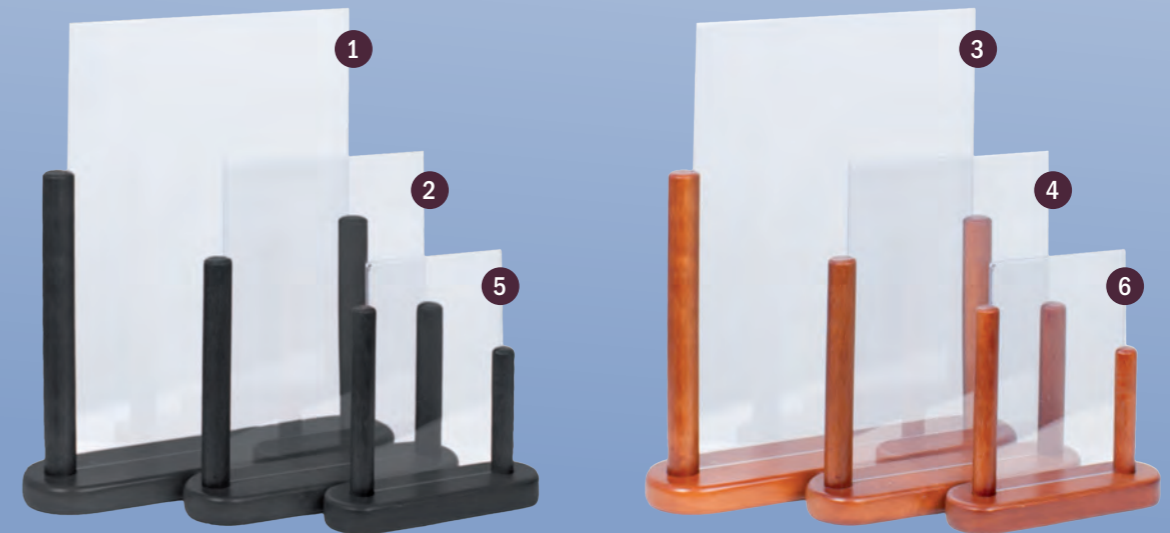

- 1 - 6 1 PFT-BL-LA | 38x32,5x7cm | 0,566kg 2 PFT-BL-ME | 30x25,5x6cm | 0,314kg
- 3 PFT-TE-LA | 38x32,5x7cm | 0,566kg 4 PFT-TE-ME | 30x25,5x6cm | 0,314kg
- 1 - 10 5 PFT-BL-SM | 23x21x5cm | 0,175kg 6 PFT-TE-SM | 23x21x5cm | 0,175kg



- 1 6 36 1 PFT-ACV-A4 | 29,7x21x21cm | 0,45kg 2 PFT-ACV-A5 | 21x14,8x15cm | 0,21kg 3 PFT-ACV-A6 | 14,8x10,5x10,5cm | 0,23kg
- 4 PFT-ACL-A4 | 29,7x21x21cm | 0,46kg 5 PFT-ACL-A5 | 21x14,8x15cm | 0,146kg 6 PFT-ACL-A6 | 14,8x10,5x10,5cm | 0,08kg
- 7 PFT-ACY-A5 | 21x14,8x13cm | 0,22kg 8 PFT-ACY-A6 | 14,8x10,5x10cm | 0,095kg

Door signs NEW

EN Wall/Door Sign - Six stainless steel signs to stick on a door or wall, knowing; man, woman, man/woman, wheelchair (friendly), arrow and no-smoking.

FR Pictogrammes murs/portes - Six pictogrammes en acier inoxydable à coller sur un mur ou une porte, à savoir: Homme, Femme, Homme/Femme, Mobilité réduite, flèche et Non-fumeur. **DE** Wand/Türzeichen - sechs Edelstahlzeichen für den Gebrauch an der Wand oder Tür; Mann, Frau, Mann/Frau, Behindertengerecht, Pfeil, Nicht-Raucher.

IT Targhette adesive in acciaio inox - Sei targhette da attaccare sulla porta o sui muri. Icone: Donna, Uomo, Donna/Uomo, Accessibile ai disabili, Freccia e Vietato Fumare. **ES** Placas adhesivas en acero inoxidable - Seis placas adhesivas en acero para pegar en la puerta o en las paredes - íconos: Mujer, Hombre, Mujer/Hombre, Accesibles, Flecha y no fumar. **PT** Sinal de parede / porta - Seis sinais de aço inoxidável; Indicativos de: Homem, mulher, cadeira de rodas (amigável), seta e não-fumadores. **CZ** Informační tabulky z nerezové oceli po montáž na dveře nebo na stěnu. 6 tabulek se symboly: Muži, Ženy, Muži/Ženy, invalidní vozík, šipka a nekuřácký prostor.



6 6 60 SI-SS-SET | 10x10x0,2cm | 0,2kg

LED sign



1



EN LED sign - LED sign to put against a wall or hang in front of a window. This sign has red, blue, green and yellow flashing lights, includes a 220v AC adaptor and has a 130cm cable.

FR Panneau LED - Panneau LED à pendre sur un mur ou le dessus d'une vitre. Ce panneau a pour couleurs de lumières qui clignotent, le rouge, bleu, vert et jaune. Un Adaptateur AC de 220V ainsi qu'un câble de 130cm est inclus avec le panneau. **DE** LED Sign - um an die Wand oder in das Fenster zu hängen. Leuchtet in rot, blau, grün und gelb, 220V AC Adapter und 130cm langes Kabel enthalten.



2



IT Insegna luminosa a LED- da mettere sul muro o da appendere in vetrina. L'insegna ha luci lampeggianti rosse, blu, verdi e gialle. Include un adattatore a 220v AC ed un cavo di 130 cm.

ES Señal luminosa de LEDs- para poner en la pared o para colgar delante de la ventana. Tiene luces intermitentes de colores rojo, azul, verde y amarillo. Incluye un adaptador de 220V AC y un cable de 130 cm. **PT** Sinal LED - Este sinal tem luzes vermelhas, azuis, verdes e amarelas, inclui um adaptador de 220v AC e tem um cabo de 130cm. **CZ** LED tabule pro zavěšení na stěnu, dveře nebo do výlohy. Obsahuje červené, modré, zelené a žluté LED diody, součástí je i adaptér na 220 V a kabel délky 130 cm.



3



1 6 1 LS-PIZZA, 2 LS-OPEN, 3 LS-BAR | 24x48x3cm | 0,89kg

INFORMATION DISPLAYS

PANNEAUX D’AFFICHAGE
INFORMATIONSDISPLAYS
ESPOSITORI INFORMATIVI
EXPOSITORES DE INFORMACIÓN
ECRÃS DE INFORMAÇÃO
INFORMAČNÍ TABULE

TAG-BO-WT
P.35



MCS-4A4-WLTE
P.116

MNI-M-KR-1
P.28



Stainless steel



EN Stainless Steel LED Display - Brushed stainless steel case for wall or pole mounting. Power by using the 5 meter cable (included) or use two Securit® batteries (not included) for a wireless solution.

FR Présentoir LED en Acier Inoxydable - Cadre en inox brossé à accrocher au mur ou à monter sur pied. S'utilise sur secteur grâce au câble de 5 mètres (inclus) ou avec les batteries Securit® (non incluses). **DE** LED Informationsdisplay aus gebürstetem Edelstahl - inkl. 5m Stromkabel. Auch kabellos mit zwei Batterien zu betreiben (nicht inklusive). **IT** Espositore a LED in Acciaio Satinato - Può essere montato a parete o su piantana. All'interno è compreso un cavo alimentatore da 5 m di lunghezza. Inoltre è possibile adoperarlo in modalità wireless acquistando a parte 2 batterie a litio ricaricabili Securit®. **ES** Expositor Luminoso LED de Acero Inoxidable - Estuche de acero inoxidable satinado para pared o montaje en poste. Electricidad con cable de 5 metros (incluido) o usando dos baterías Securit® (no incluidas) para usarlo sin cables. **PT** Exibição de Aço Inoxidável LED - Capa de aço inoxidável escovado para montagem em paredes ou postes. Energia utilizando o cabo de 5 metros (incluído) ou utilize as duas baterias Securit® (não incluídas) para uma solução sem fios. **CZ** Nerezové LED Informační Tabule - Z kartáčované nerezové oceli pro umístění na stěně nebo se stojanem. Napájení pomocí 5 m kabelu nebo 2 akumulátorů Securit® (není součástí dodávky) pro bezdrátové použití.



1 MCS-6A4-LSS | 99x52x5cm | 21kg 2 MCS-4A4-LSS | 69x52x5cm | 15kg
 3 MCS-BA-120-G1 | 120x15x6cm | 3,8kg 4 MCS-BA-G2 | 43x38x3cm | 10,2kg 5 + 4 MCS-BA-120-SET | 120x15x6cm | 3,8kg
 1 24 5 MCS-BATT | 16,5x7,5x1cm | 0,4kg

Coated steel

EN Coated Steel LED Display - Gun grey steel case for wall or pole mounting. Power by using the 5 meter cable (included) or use a Securit® battery (not included) for a wireless solution (Use 2 batteries for MCS-6A4-CS).

FR Présentoir LED en Acier Galvanisé - Cadre gris métallisé à accrocher au mur ou à monter sur pied. S'utilise sur secteur grâce au câble de 5 mètres (inclus) ou avec les batteries Securit® (non incluses). (Utilisez 2 batteries pour le modèle MCS-6A4-CS). **DE** LED pulverlackbeschichtetes Informationsdisplay - inkl. 5m Stromkabel. Auch kabellos mit einer Batterie zu betreiben (nicht inklusive). Auch für das Modell MCS-6A4-CS. **IT** Espositore a LED in Acciaio Rivestito Color Grigio Metallizzato - Può essere montato a parete oppure utilizzato con piantana. All'interno è compreso un cavo alimentare da 5 m di lunghezza oppure è possibile adoperarlo in modalità wireless acquistando a parte 2 batterie a litio ricaricabili Securit®. Utilizzare 2 batterie per il modello MCS-6A4-CS. **ES** Expositor LED de Acero Revestido - Estuche de acero gris metálico para pared o montaje en poste. Electricidad con cable de 5 metros (incluido) o usando batería Securit® (no incluida) para usarlo sin cable (usa dos batería para MCS-6A4-CS). **PT** Display de LED Revestida a Aço - Capa cinza metálico para montagem em paredes ou postes. energia utilizando o cabo de 5 metros (incluído) ou utilize uma bateria Securit® (não incluída) para uma solução sem fios (use duas baterias para MCS-6A4-CS). **CZ** Lakované LED Informační Tabule - Z šedě lakované oceli, pro umístění na stěně nebo se stojanem. Napájení pomocí 5 m kabelu nebo 2 akumulátorů Securit® (není součástí dodávky) pro bezdrátové použití.

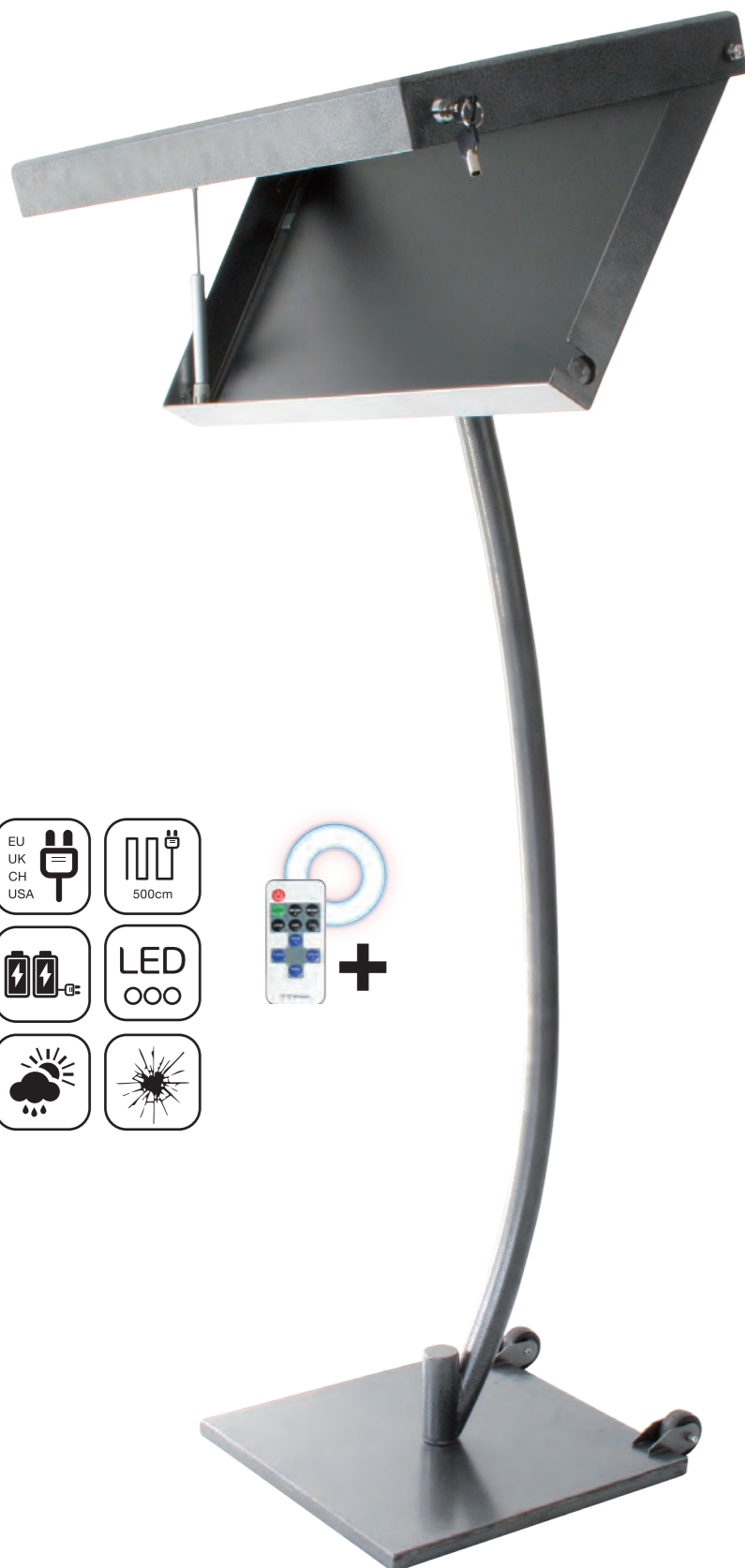
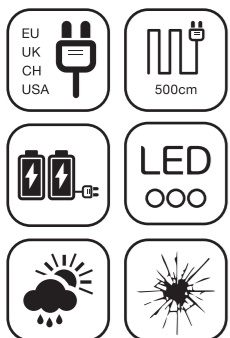

- 1 MCS-3A4-CS | 40x72x5cm | 13kg
- 2 MCS-6A4-CS | 68x72x5cm | 21kg
- 3 MCS-BA-135-E3 | 135x9x4cm | 3kg
- 4 MCS-BA-95-E2 | 95x9x4cm | 3kg
- 5 MCS-BA-E1 | 44x40x3cm | 11,6kg
- 6 MCS-BATT | 16,5x7,5x1cm | 0,4kg



1 MCS-4A4-WLSS, 2 MCS-4A4-WLDB, 3 MCS-4A4-WLTE | 70x35x6cm | 8,9kg
 4 MCS-BA-125-SET | 125x40x40cm | 14,6kg 5 MCS-WH-2 | 9x11,7x5cm | 0,7kg 6 MCS-BATT | 16,5x7,5x1cm | 0,4kg

Classic

EN Classic LED Display - Wooden style or brushed stainless steel case for wall or pole mounting. Power by using the 5 meter cable or use one Securit® battery (not included) for a wireless solution.

FR Présentoir LED Classic - Cadre en acier brossé ou en bois à accrocher au mur ou à monter sur pied. S'utilise sur secteur grâce au câble de 5 mètres (inclus) ou avec une batterie Securit® (non incluse).

DE Klassisches LED Informationsdisplay - In Holzoptik oder aus gebürstetem Edelstahl. Für die Wandmontage oder mit Standfuss zu erwerben. Inkl. 5m Stromkabel. Auch kabellos mit zwei Batterien zu betreiben (nicht inklusive).

IT Espositore a LED Classic - Disponibile in legno o in acciaio satinato. Montabile a parete o su piantana. Comprende 5 metri di cavo ma utilizzabile anche wireless con l'opzione batteria (non compresa).

ES Expositor de LEDs Clásico - Expositor en madera o en acero inoxidable satinado para pared o montaje en poste. Electricidad con cable de 5 metros (incluido) o usando batería Securit® (no incluida) para usarlo sin cable.

PT Display LED Clássica - Capa de aço inoxidável escovado para montagem em postes ou paredes. Obtenha energia utilizando o cabo de 5 metros ou usando uma bateria Securit® (não incluída) para uma solução sem fios. **CZ** Informaní LED tabule Classic - Rám z masivního dřeva nebo nerezové oceli pro umístění na stěnu nebo na stojan. Napájení pomocí 5 m kabelu nebo akumulátoru Securit® (není součástí dodávky) pro bezdrátové použití.

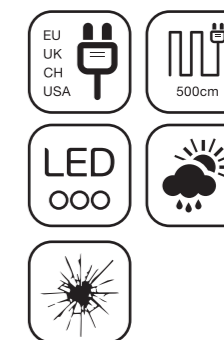

Black star

EN Coated Steel LED Display - Black steel case for wall or pole mounting. Power by using the 5 meter cable (included) or use one Securit® battery (not included) for a wireless solution.

FR Présentoir LED en Acier Inoxydable / Black Star - Cadre en acier noir à accrocher au mur ou à monter sur pied. S'utilise sur secteur grâce au câble de 5 mètres (inclus) ou avec les batteries Securit® (non incluses). **DE** Pulverlackbeschichtetes Stahl LED Informationsdisplay, schwarz - inkl. 5m Stromkabel. Auch kabellos mit einer Batterie zu betreiben (nicht inklusive). **IT** Espositore a LED Black Star - Realizzato in acciaio nero rivestito. Può essere montato a parete od utilizzato con piantana (compresa). All'interno è compreso un cavo alimentatore da 5 m di lunghezza oppure è possibile adoperarlo in modalità wireless acquistando a parte 1 batteria a litio ricaricabile.

ES Expositor de LEDs en Acero Revestido - Estuche de acero negro para pared o montaje en poste. Electricidad con cable de 5 metros (incluido) o usando batería Securit® (no incluida) para usarlo sin cable. **PT** Display de LED Revestida a Aço - Capa preta de aço para paredes ou montagem em paredes ou postes. Energia energia utilizando o cabo de 5 metros (incluido) ou utilize uma bateria Securit® (não incluída) para uma solução sem fios.

CZ Lakované LED Informační Tabule - Z černě lakované oceli, pro umístění na stěně nebo se stojanem. Napájení pomocí 5 m kabelu nebo 2 akumulátorů Securit® (není součástí dodávky) pro bezdrátové použití.

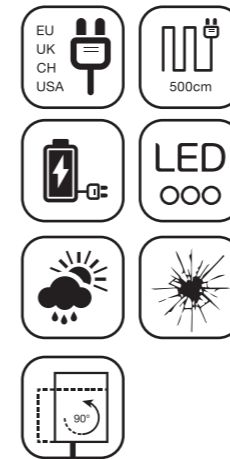

- 1 MCS-4A4-BL-SET | 144x50x5cm | 22kg 2 MCS-WH-2 | 9x11,7x5cm | 0.7kg
1 24 3 MCS-BATT | 16,5x7,5x1cm | 0,4kg



Rustic

EN Rustic LED Display - Wooden case with a zinc roof for wall or pole mounting. Power by using the 5 meter cable or use one Securit® battery (not included) for a wireless solution.

FR Présentoir LED Rustic - Cadre en bois avec toit en zinc à accrocher au mur ou à monter sur pied. S'utilise sur secteur grâce au câble de 5 mètres (inclus) ou avec une batterie Securit® (non incluse). **DE** LED Informationsdisplay "Rustic" - Holz Informationsdisplay mit Zinkdach - inkl. 5m Stromkabel. Auch kabellos mit einer Batterie zu betreiben (nicht inklusive). **IT** Espositore a LED Rustic - Realizzato in legno con parti superiori in zinco. Montabile a parete o su piantana. Comprende 5 metri di cavo ma utilizzabile anche wireless con l'opzione batteria (non compresa). **ES** Expositor de LEDs Rústico - Expositor de madera con techo de zinc para montaje en pared o poste. Electricidad con cable de 5 metros (incluido) o usando batería Securit® (no incluida) para usarlo sin cable. **PT** Display LED Zink - Capa de madeira com um teto de zinco para montagem em postes ou paredes. Obtenha energia utilizando o cabo de 5 metros ou utilize uma das baterias Securit® (não incluídas) para uma solução sem fios. **CZ** Informační LED Tabule - Rám ze zinkované oceli pro umístění na stěnu nebo na stojan. Napájení pomocí 5 m kabelu nebo akumulátoru Securit® (není součástí dodávky) pro bezdrátové použití.



1 MCS-4A4-WLR-SET | 175x53x40cm | 20kg 2 MCS-4A4-WLR | 82x53x7cm | 3,9kg
3 MCS-WH-2 | 9x11,7x5cm | 0,7kg 4 MCS-BATT | 16,5x7,5x1cm | 0,4kg



Acrylic

EN Acrylic LED Display - Display on the table (stand included), for mounting to the wall or on a 95cm pole (MCS-BA-95) / 135cm pole (MCS-BA-135).

FR Présentoir LED Acrylic - Cadre en acrylique noir très résistant, à poser (support inclus), à accrocher au mur ou à monter sur pied de 95cm (MCS-BA-95) ou de 135cm (MCS-BA-135). **DE** Acryl-LED Informationsdisplay - Hardplastik Informationsdisplay für den Tisch. (Inklusiv Stand). Es kann mit 95cm (MCS-BA-95) oder 135cm (MCS-BA-135) Standfuß oder an die Wand montiert werden. **IT** Espositore a LED in Acrilico da Tavola (base inclusa) - Può essere montato anche a parete o su piantana da 95cm (MCS-BA-95) o da 135cm (MCS-BA-135). **ES** Expositor de LEDs en Acrílico - Expositor de sobremesa (soporte incluido) para montar en la pared o sobre un poste de 95cm (MCS-BA-95) / poste de 135cm (MCS-BA-135). **PT** Display LED Acrílico - Capa dura de plástico para exibição na mesa (suporte incluído), para montar na parede ou num poste de 95cm (MCS-BA-95) / 135cm (MCS-BA-135). **CZ** Akrylátové LED Tabule - Vyrobeny z tvrdého plastu pro umístění na stůl (stojan součástí dodávky), pro umístění na stěnu, na stojan o výšce 95cm (MCS-BA-95) nebo 135cm (MCS-BA-135).



1 MCS-2A4-PA | 55x54x8,7cm | 3,36kg 2 MCS-BA-135-E3 | 135x9x4cm | 3kg
3 MCS-BA-95-E2 | 95x9x4cm | 3kg 4 MCS-BA-E1 | 44x40x3cm | 11,6kg

Securit®
PROMOTES
your
BUSINESS

👍 @SECURIT.NL
🐦 📷 📱 #SECURIT_NL

Menu stand

EN Wooden Menu Stand - Menu stand to display menu's or other information on.

FR Porte-Menu en Bois sur pieds- Permetts l'affichage en présentation de menu ou autres informations sur le présentoir. **DE** Hölzerner Menü Ständer - Menü Ständer um Informationen oder Speisekarten auszustellen. **IT** Leggio Portamenu - Realizzato in Legno con base in acciaio inox. Ideale per esporre il menu del giorno fuori dal ristorante o all'entrata di un buffet. **ES** Atril Porta Menús - realizado en madera con base en acero inoxidable. Ideal para exhibir el menú del día fuera del restaurante o en la entrada de un buffet.

PT Suporte de Menu - Suporte de menu em madeira para exibir o menu ou outro tipo de informação sobre a carta ou o estabelecimento.

CZ Dřevěný stojan pro umístění jídelních lístků nebo dalších informací.



1 - 1 MCS-115-TE | 115x54cm | 3,4kg 2 - 1 MCS-WH-2 | 9x11,7x5cm | 0,7kg
1 - 1 MCS-BATT | 16,5x7,5x1cm | 0,4kg 1 - 1 LP-BL-1 | 31x7,5x11cm | 0,5kg

Glass star

EN Glass Star Information Display - Hard wooden display with a stainless steel style edge and a front glass plate.

FR Panneaux d’Affichage Glass Star - Support en bois dur avec bordures en acier, protégé par une plaque en verre. **DE** Informationsdisplay "Glass Star" - Hartholz Display mit Edelstahlumrandung und einer Glasplatte oben auf. **IT** Espositore Glass Star - Espositore realizzato in legno duro con un bordo in acciaio inox ed un elegantissimo vetro protettivo frontale. **ES** Expositor Glass Star - Expositor de madera dura con borde de acero inoxidable y placa de cristal frontal. **PT** Display de Informação em Estrela de Vidro – Display com uma margem de aço inoxidável e uma placa frontal.

CZ Informační Tabule Glass Star - Rám z tvrdého dřeva v kombinaci s nerezovou ocelí, elní skleněná deska.



1 - 2 - 3 - 4 - 5 - 6 - 7 - 8 - 9
 1 MCS-4A4-WAL, 2 MCS-4A4-OAK | 75x57x3cm | 9,3kg 3 MCS-A4-WAL, 4 MCS-A4-OAK | 37x28x3cm | 3,4kg
 5 MCS-BA-125-SET | 125x40x40cm | 14,6kg 6 MCS-BA-85-SET | 85x27x27cm | 7,3kg 7 MCS-WH-2 | 9x11,7x5cm | 0,7kg
 8 MCS-BATT | 16,5x7,5x1cm | 0,4kg 9 LP-BL-1 | 31x7,5x11cm | 0,5kg

Securit®

RS-CL-GO-SET
P.130

RS-CLRP-GOBL
P.132

RS-200-BL
P.133

BARRIER SYSTEMS

POTEAUX D'ACCUEIL

ABSPERRSYSTEME

COLONNE SEGNAPERCORSO

POSTES DE ACOGIDA

POSTES SEPARADORES

ZÁBRANOVÉ SYSTÉMY



Classic

EN Classic Barrier - Polished high-grade stainless steel with anti-scratch base to protect floors and a screw top to add accessories, such as thick strong ropes with polished steel clips.

FR Poteaux d'Accueil Classic - Poteaux en acier inoxydable de haute qualité, protections anti-rayures sur le socle et corde résistante avec accroche en inox. **DE** Klassischer Absperrpfosten - hochwertiger Edelstahlpfosten mit Kratzschutz für Böden. Schraubverschluss um Zubehör darauf befestigen zu können. Dicke Seile mit polierten Endstücken.

IT Colonnine Segnapercorso con Cordone - Realizzate in acciaio inossidabile lucido di altissima qualità. La base è antigraffio per la protezione dei pavimenti e l'estremità dell'asse è rimovibile per l'aggiunta dell'espositore. Cordoni spessi resistenti e con moschettoni in acciaio lucido. **ES** Postes de Acogida Clásicos - Acero inoxidable de alta calidad pulido con base antiarañazos para proteger el suelo y cierre de rosca para añadir accesorios. Cuerdas gruesas y robustas con enganches de acero inoxidable.

PT Barreira Clássica - Base de aço inoxidável polido para proteger chão e uma tampa de rosca para adicionar acessórios. Cordas espessas com cliques de aço polido. **CZ** Zábranový Systém Clasic - Vyroben z vysoce kvalitní leštěné nerezové oceli. Podstavec v úpravě proti poškrábání podlahy. Šroubovací uzávěr pro instalaci doplňků. Ozdobná lana s ocelovými karabinami.

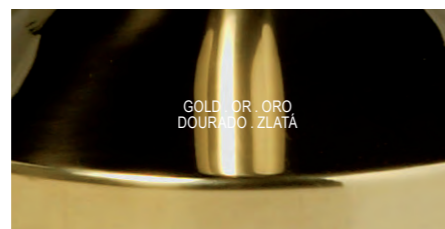

- 1 2 3
1 RS-CL-GO-A1 | 86x5x5cm | 1,2kg
2 RS-CL-GO-A2 | 31x31x8cm | 9,6kg
1 + 2 RS-CL-GO-SET | 97x31x31cm | 12,5kg

- 1 2 3
3 RS-CL-CH-B1 | 86x5x5cm | 1,4kg
4 RS-CL-CH-B2 | 31x31x33cm | 9,4kg
3 + 4 RS-CL-CH-SET | 97x31x31cm | 12,5kg

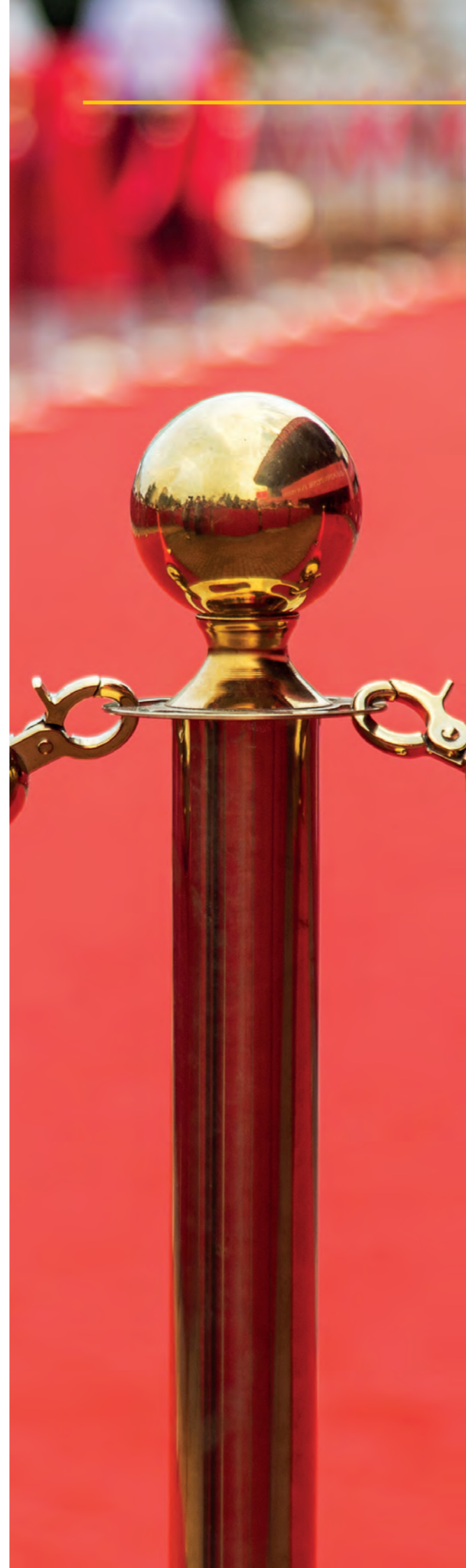

- 1 2 3
RS-LW-CH | 95x32x48cm | 16,5kg

Accessories

Ropes

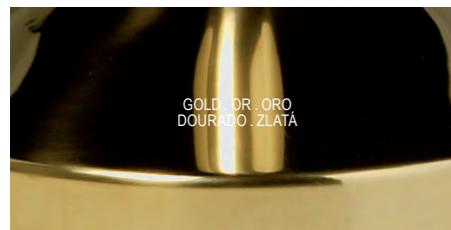

- 1 - 5
- 1 RS-CLRP-GOWT, 2 RS-CLRP-GOBR,
 - 3 RS-CLRP-GOBL, 4 RS-CLRP-GOBU,
 - 5 RS-CLRP-GORD | 150x4x4cm | 0,56kg

- 1 - 5
- 1 RS-CLRP-CHWT, 2 RS-CLRP-CHBR,
 - 3 RS-CLRP-CHBL, 4 RS-CLRP-CHBU,
 - 5 RS-CLRP-CHRD | 150x4x4cm | 0,56kg

Sign



- 1 - 5
- 6 RS-SIGN-A4-PG | 46x24x2cm | 0,88kg
 - 7 RS-SIGN-A4-PC | 46x24x2cm | 0,88kg

Carpet NEW

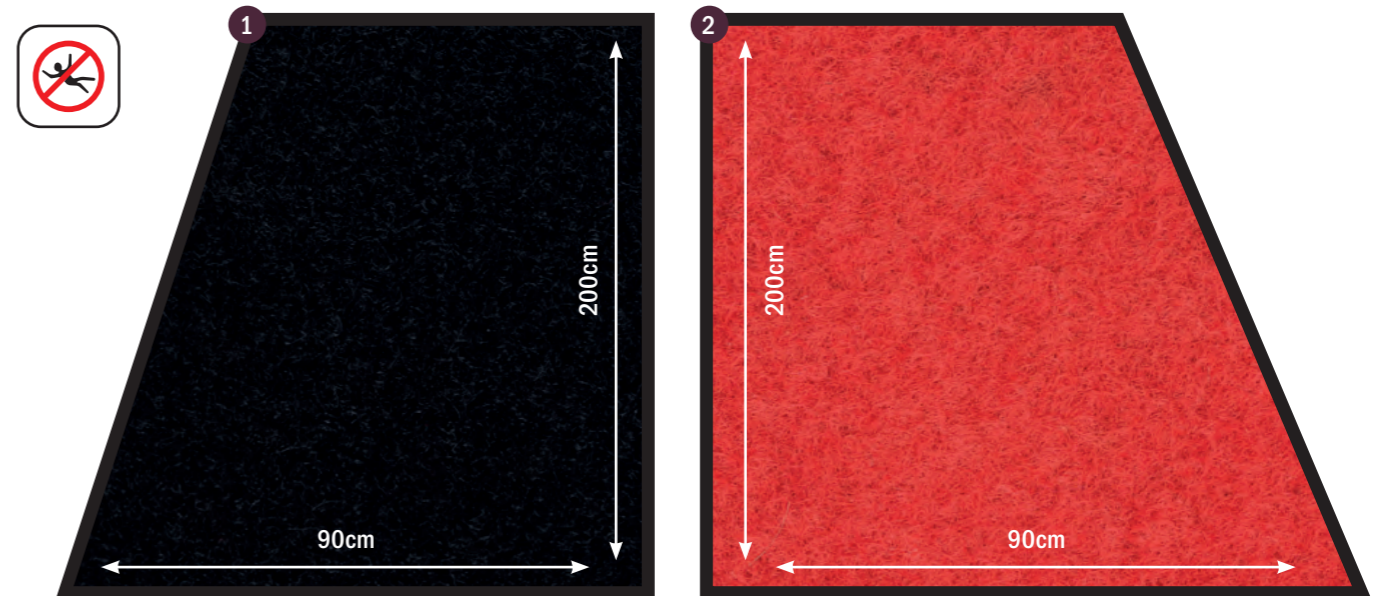

- 1 - 3
- 1 RS-200-BL | 200x90cm
 - 2 RS-200-RD | 200x90cm

Wall



- 1 - 3
- 1 RS-CLWH-GO | 5x5x4cm | 0,089kg
 - 2 RS-CLWH-CH | 5x5x4cm | 0,089kg



- 1 RS-RT-RVS-BL-C4,
- 2 RS-RT-RVS-GY-C2, 3 RS-RT-RVS-RD-C1,
- 4 RS-RT-RVS-BU-C5 | 93x7x7cm | 1,8kg
- 5 RS-RT-RVS-C3 | 31x31x8cm | 9,8kg

- 1 RS-RT-RVS-RD-SET, 2 RS-RT-RVS-BL-SET,
- 3 RS-RT-RVS-GY-SET | 101x31x31cm | 12,8kg

wall mounting

sign

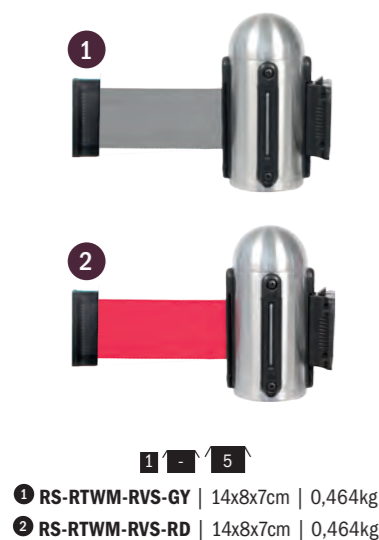

- 1 RS-RTWM-RVS-GY | 14x8x7cm | 0,464kg
- 2 RS-RTWM-RVS-RD | 14x8x7cm | 0,464kg

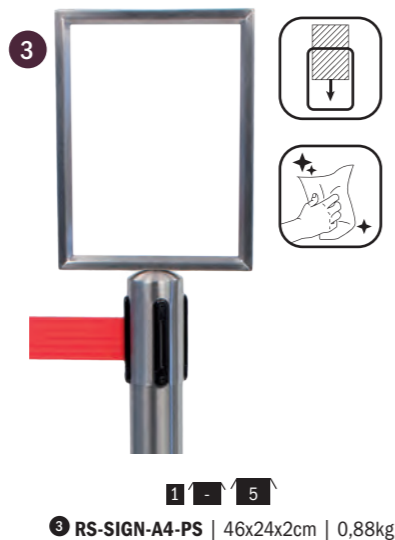

- 3 RS-SIGN-A4-PS | 46x24x2cm | 0,88kg



- 4 RS-RT-BL-C8 | 93x12x7cm | 1,5kg
- 5 RS-RT-BL-C9 | 33x33x5cm | 9,8kg

Retractable

EN Retractable Barrier - Brushed or coated black high-grade stainless steel with anti-scratch base to protect floors and a screw top for adding accessories. 210cm retractable tape included.

FR Poteaux d'Accueil à Corde Retractable - Poteau en inox brossé, protections anti-rayures sur le socle et corde retractable de 210cm intégrée. **DE** Leit- und Absperrsystem - aus poliertem Edelstahl oder pulverlackbeschichtetem Stahl mit Kratzschutz für Böden. Schraubverschluss um Zubehör darauf befestigen zu können. Dicke Seile mit polierten Endstücken. Band ausziehbar bis 210cm. **IT** Colonnine Segnapercorso con Nastro Retrattile - Disponibile in acciaio satinato o in acciaio rivestito nero. La base è antigraffio per la protezione dei pavimenti mentre la parte superiore dell'asse è rimovibile per l'aggiunta dell'espositore. Nastro retrattile da 210cm. **ES** Postes de Acogida Retrátiles - Acero inoxidable satinado o recubierto negro base antiarañazos para proteger el suelo y cierre de rosca para añadir accesorios. Cinta de 210cm retráctil incluida. **PT** Barreira Retrátíl - Aço inoxidável preto escovado ou coberto com base anti riscos para proteger chãos e uma tampa de rosca para adicionar acessórios. 210cm de fita retrátíl incluida. **CZ** Natahovací Zábranový Systém - Z kartáčované nebo černě lakované nerezové oceli. Podstavec v úpravě proti poškrábání podlahy, šroubovací uzávěry pro přidání příslušenství. Součástí je 210cm dlouhá páska se sponou.



Budget

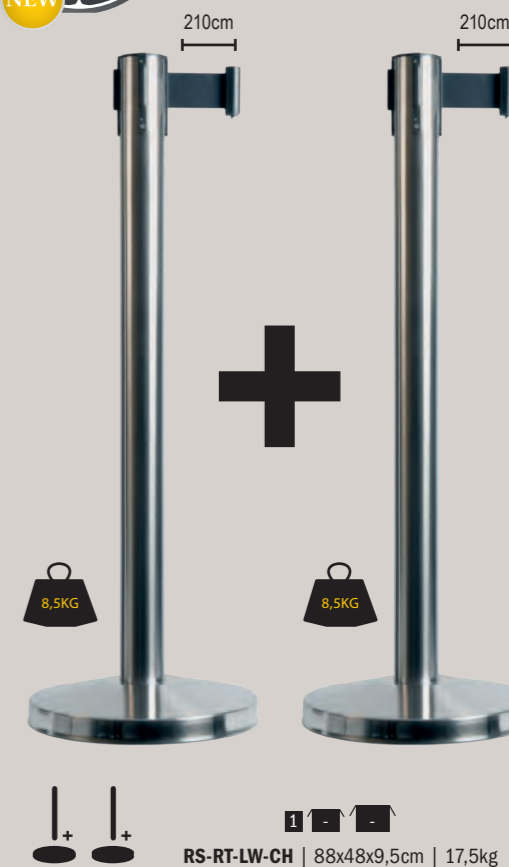

- 1 RS-RT-LW-CH | 88x48x9,5cm | 17,5kg



Smoker poles

EN Smokers Pole - Brushed or coated black high-grade stainless steel. Free standing or wall mounted model.

FR Cendriers - En inox brossé ou noir de haute qualité, à poser ou à accrocher au mur. Ce cendrier dispose également d'un système de vidange propre et très pratique.

DE Der Standascher - Hochwertigem Edelstahl im Schwarz oder Silber. Erhältlich in 2 Ausführungen: Ein Standmodell und ein Wandmontagemodell. Die Asche aus dem innenrohr der Stange ist auf einem einfachen und sauberen Weg zu Leeren.

IT Posaceneri - Acciaio spazzolato o rivestito nero di alta qualità. Entrambi i modelli a colonna e a parete hanno un sistema di svuotamento facile e pulito.

ES Ceniceros - De acero inoxidable de alta calidad satinado o revestido negro. De pie o de pared, con sistema de vaciado simple y limpio. **PT** Cinzeiros - Aço inoxidável preto escovado ou revestido fixo ou modelo incorporado na parede com um sistema de limpeza e esvaziamento simples.

CZ Popelníky - Z kartáčované nebo černě barvené nerezové oceli. Dodávají se ve stojanové verzi nebo pro instalaci na stěnu. Snadné vysypání.



- 1
- 1 **SP-SS-SM-F2** | 100x6x6cm | 1,7kg
- 2 **SP-SS-SM-F1** | 24x24x4cm | 4kg
- 3 **SP-BL-SM-F2** | 100x6x6cm | 1,58kg
- 4 **SP-BL-SM-F1** | 24x24x4cm | 4kg
- 1
- 5 **SP-SS-WM** | 51x11x6cm | 1,3kg

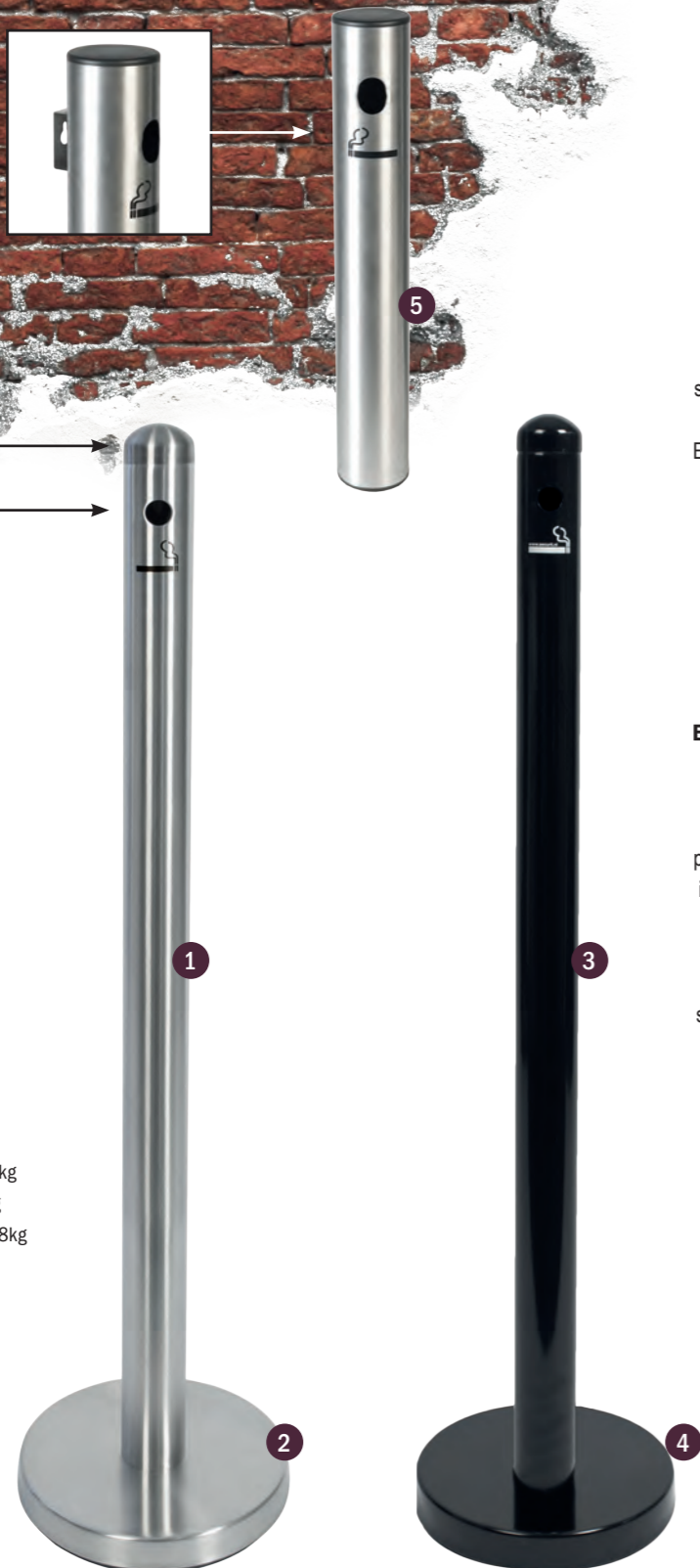

Securit®

STORE DISPLAYS



POS-DISPLAY-5

9+ SKUs



POS-DISPLAY-12

80x120x145cm
40+ SKUs

NEW
POS-DISPLAY-17

40x40x2000cm
20+ SKUs

POS-DISPLAY-10

80x60x145cm
16+ SKUs

NEW
POS-DISPLAY-18

80x60x145cm
30+ SKUs



POS-DISPLAY-6

80x120x55cm



POS-DISPLAY-8

41x40x14cm
 16 SKUs
 10x SMA510-XX
 6x SMA720-XX



POS-DISPLAY-14

40x35x20



POS 18
 P.139

Securit®
 STORE
 DISPLAYS

Icons

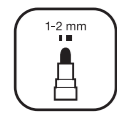

EN 1-2mm writing nib. **FR** Pointe de 1-2 mm. **DE** 1-2 mm Schreibfeder. **IT** Scrittura da 1-2 mm. **ES** Trazo 1-2 mm. **PT** Caneta tinteiro de 1-2mm. **CZ** Hrot 1-2 mm.



EN 2-6mm writing nib. **FR** Pointe de 2-6 mm. **DE** 2- 6 mm Schreibfeder. **IT** Scrittura da 2-6 mm. **ES** Trazo 2-6 mm. **PT** Caneta tinteiro de 2-6mm. **CZ** Hrot 2-6 mm.

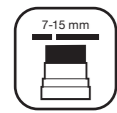

EN 7-15mm writing nib. **FR** Pointe de 7-15 mm. **DE** 7-15 mm Schreibfeder. **IT** Scrittura da 7-15 mm. **ES** Trazo 7-15 mm. **PT** Caneta tinteiro de 7-15mm. **CZ** Hrot 7-15 mm.



EN For use with chalkmarker. **FR** À utiliser avec des feutre-craie. **DE** Zur Verwendung mit Kreidemarker. **IT** Per l'utilizzo con gesso liquido. **ES** Para usar con marcador de tiza liquido. **PT** Para utilização com marcador de giz líquido. **CZ** Pro použití s křídovým popisovačem.



EN Write on the surface. **FR** Écrivez sur la surface. **DE** Beschreiben der Tafel. **IT** Scrivere sulla superficie. **ES** Escribe en la superficie. **PT** Escreva na superfície. **CZ** Piště na plochu.



EN Clean with Securit® cleaner. **FR** À nettoyer avec le spray nettoyant Securit®. **DE** Reinigen mit Securit® Reiniger. **IT** Pulire con detergente Securit®. **ES** Limpiar con limpiador Securit®. **PT** Limpe com limpiador Securit®. **CZ** Smažte pomocí čističe Securit.



EN Add water to sponge. **FR** Mouillez une éponge. **DE** Schwamm befeuchten. **IT** Bagnare la spugna. **ES** Mojar una esponja. **PT** Molhar a esponja. **CZ** Namočte houbičku.



EN Erase with wet sponge. **FR** Effacez à l'eau. **DE** Reinigen mit feuchtem Schwamm. **IT** Cancellare con spugna bagnata. **ES** Borrer con agua. **PT** Apagar com água. **CZ** Namočte houbičku.



EN Easy to clean. **FR** Facile à nettoyer. **DE** Einfach zu reinigen. **IT** Facile da pulire. **ES** Fácil de limpiar. **PT** Fácil de limpar. **CZ** Snadné čištění.



EN Weather-resistant. **FR** Résiste à la pluie et aux UV. **DE** Wetterbeständig. **IT** Resistente agli agenti atmosferici. **ES** Resiste a la lluvia y a los rayos UV. **PT** Resiste à chuva e aos raios UV. **CZ** Odolné povětrnostním podmínkám.



EN UV resistant. **FR** Résistant aux UV. **DE** UV-beständig. **IT** Resistente ai raggi UV. **ES** Resistente a rayos UV. **PT** Resistente a UV. **CZ** Odolné UV.



EN Detachable. **FR** Détachable. **DE** Abnehmbar. **IT** Rimovibile. **ES** Extraíble. **PT** Destacável. **CZ** Vyměnitelný.

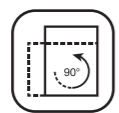

EN Display portrait or landscape. **FR** Portrait ou paysage. **DE** Hoch order Querformat. **IT** Utilizzabile verticalmente e orizzontalmente. **ES** Expositor vertical y horizontal. **PT** Exibição Vertical ou Horizontal. **CZ** Lze umístit na šířku i na výšku.

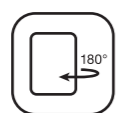

EN Double sided. **FR** Double face. **DE** Doppelseitig. **IT** Bifacciale. **ES** De doble cara. **PT** Dupla face. **CZ** Oboustranné provedení.



EN Safety glass. **FR** Vitre de sécurité. **DE** Sicherheitsglas. **IT** Cristallo di sicurezza. **ES** Vidrio de seguridad. **PT** Vidro de segurança. **CZ** Bezpečnostní sklo.



EN 5* Hard quality wood. **FR** Bois dur de qualité 5*. **DE** 5* hochwertigem Holz. **IT** Legno duro qualità 5*. **ES** Madera de calidad dura 5*. **PT** Madeira endurecida de qualidade 5*. **CZ** 5* Kvalitní tvrdé dřevo. **AR** 5* خشب صلب عالي الجودة



EN Including wall mounting supplies. **FR** Système d'accroche mural inclus. **DE** Inklusive Dübel und Schrauben zur Befestigung. **IT** Include kit montaggio a parete. **ES** Incluye bisagras de montaje de pared. **PT** Inclui montagem na parede dobradiças. **CZ** Obsahuje příslušenství pro instalaci na stěnu.



EN Including 2 wall mounting screw hooks. **FR** 2 Crochets pour suspension murale inclus. **DE** Inklusive Schrauben/Haken. **IT** Include 2 viti per montaggio a parete. **ES** Incluyendo gancho de tornillo. **PT** Incluindo gancho parafuso. **CZ** Obsahuje 2 skoby pro instalaci na stěnu.

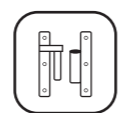

EN Including Securit® hinges with security lock. **FR** Charnières Securit® avec système de sécurité inclus. **DE** Inklusive Securit® Scharniere. **IT** Include sistemi di collegamento con chiusura di sicurezza. **ES** Incluye bisagras con cierre de seguridad. **PT** Inclui dobradiças com fecho de segurança. **CZ** Včetně bezpečnostních.



EN White LEDs. **FR** Leds blanches. **DE** Weiße LED Lampen. **IT** LED bianchi. **ES** LEDs blancos. **PT** LEDs Brancas. **CZ** Bílé LED diody.



EN Compatible with 1 Securit® rechargeable battery. **FR** Compatible avec 1 batterie Securit®. **DE** Kompatibel mit 1 Securit® Batterie. **IT** Compatibile con 1 batteria Securit®. **ES** Compatible con 1 batería Securit®. **PT** Compatível com 1 bateria Securit®. **CZ** Kompatibilní s akumulátorem Securit®.

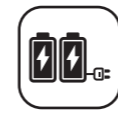

EN Compatible with 2 Securit® rechargeable batteries. **FR** Compatible avec 2 batteries Securit®. **DE** Kompatibel mit 2 Securit® Batterien. **IT** Compatibile con 2 batterie Securit®. **ES** Compatible con 2 baterias Securit®. **PT** Compatível com 2 baterias Securit®. **CZ** Kompatibilní se 2 akumulátory Securit®.

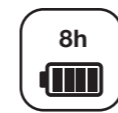

EN battery time. **FR** Autonomie de la batterie. **DE** Batterielaufzeit. **IT** Durata batteria. **ES** horas de batería. **PT** Bateria de duração. **CZ** Výdrž baterie.



EN 500cm power cable. **FR** Câble d'alimentation de 500 cm. **DE** 500 cm Stromkabel. **IT** Cavo di alimentazione di 500 cm. **ES** Cable de 5m. **PT** Cabo elétrico de 500 cm. **CZ** 500cm přívodní kabel.



EN UK, USA, CH, EU electric plugs included. **FR** Prises électriques UK, USA, CH, EU incluses. **DE** Stecker verfügbar in UK,USA,CH, EU. **IT** Comprende spina elettrica per IT, EU, CH, UK. **ES** Incluye adaptor por ES, EU, UK, USA, SZ. **PT** Inclui adaptador para PT,UE, Reino Unido, EUA, SZ. **CZ** UK, USA, CH, EU elektrické zástrčky součástí dodávky.



EN On/Off switch. **FR** Interrupteur Marche/ Arrêt. **DE** Ein/Ausschalter. **IT** Pulsante On/ Off. **ES** Interruptor de encendido y apagado. **PT** Interruptor Ligado/Desligado. **CZ** Vypínač.



EN Magnetic. **FR** Aimanté. **DE** Magnetisch. **IT** Magnetico. **ES** Magnético. **PT** Magnético. **CZ** Magnetický materiál. **AR** مغناطيسي



EN Including 6 fixed inserts. **FR** 6 inserts fixes inclus. **DE** Inklusive 6 feste Einlagen. **IT** 6 inserti fissi inclusi. **ES** 6 fundas fijas incluidas. **PT** 6 protector de folhas fixos incluídos. **CZ** Včetně 6 pevných vloček.



EN Including 1 removable insert. Additional inserts sold separately. **FR** 1 insert amovible inclus. Les inserts supplémentaires sont vendus séparément. **DE** Inklusive 1 Einlage. Zusätzliche Einlagen separat erhältlich. **IT** 1 inserto incluso. Inserti aggiuntivi venduti separatamente. **ES** 1 funda incluido. Fundas adicionales vendidas por separado. **PT** 1 protector de folhas incluído. Protectores de folhas adicionais vendidos .em separado. **CZ** Včetně 1 vločky. Další vločky v prodeji samostatně.



EN Elastic inner cord for adding inserts. **FR** Elastique intérieur permettant d'ajouter des inserts. **DE** Elastisches Innenband zum Hinzufügen von Einlagen. **IT** Elastico centrale interno per aggiungere/rimuovere inserti. **ES** Cordón interior elástico para añadir fundas. **PT** Elástico interno para adicionar protector de folhas. **CZ** Elastická vnitřní šňůra pro přidávání vloček.

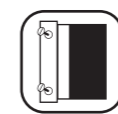

EN Removable screws for adding inserts. **FR** Vis amovibles permettant d'ajouter des inserts. **DE** Lösbare Schrauben zum Hinzufügen von Einlagen. **IT** Viti rimuovibili per aggiungere inserti. **ES** Tornillos extraíbles para añadir fundas. **PT** Parafusos amovíveis para adicionar protector de folhas. **CZ** Odnímatelné šrouby pro přidávání vloček.

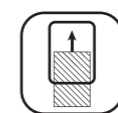

EN Removable. **FR** Amovible. **DE** Abnehmbar. **IT** Rimovibile. **ES** Desmontable. **PT** Amovível. **CZ** Odnímatelné provedení.



EN PVC. **FR** PVC. **DE** PVC. **IT** PVC. **ES** PVC. **PT** PVC. **CZ** PVC.



EN Polypropylene. **FR** Polypropylène. **DE** Polypropylen. **IT** Polipropilene. **ES** Polipropileno. **PT** Polipropileno. **CZ** Polypropylen.

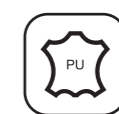

EN Polyurethane. **FR** Polyuréthane. **DE** Polyurethan. **IT** Poliuretano. **ES** Poliuretano. **PT** Poliuretano. **CZ** Polyuretan.



EN 4 Connection points. **FR** 4 Points de connexion. **DE** 4 Anschlussmöglichkeiten. **IT** 4 Punti di connessione. **ES** 4 Puntos de conexión. **PT** 4 Pontos de conexão. **CZ** 4 spojovací body.



EN Stable. **FR** Stable. **DE** Stabil. **IT** Stabilità. **ES** Estabilidad. **PT** Estabilidade. **CZ** Stabilní.

Index

B

BL-SMA100-V2-GDSL	68
BL-SMA100-V2-WT	68
BL-SMA100-V4-COL	68
BL-SMA100-V4-TRO	68
BL-SMA100-V4-WHI	68
BL-SMA100-V7-AS	68
BL-SMA100-V7-WT	68
BL-SMA510-BU	68
BL-SMA510-GD	68
BL-SMA510-GR	68
BL-SMA510-OR	68
BL-SMA510-PI	68
BL-SMA510-RD	68
BL-SMA510-SL	68
BL-SMA510-VT	68
BL-SMA510-WT	68
BL-SMA510-YE	68
BL-SMA720-BU	69
BL-SMA720-GR	69
BL-SMA720-OR	69
BL-SMA720-PI	69
BL-SMA720-RD	69
BL-SMA720-VT	69
BL-SMA720-WT	69
BL-SMA720-YE	69
BL-SMAMIX-V5-WT	68
ELE-B-SM	27
ELE-DB-LA	27
ELE-DB-ME	27
ELE-M-LA	27
ELE-M-ME	27
ELE-M-SM	27
ELE-S-LA	27
ELE-S-ME	27
ELE-S-SM	27
ELE-TE-LA	27
ELE-TE-ME	27
ELE-TE-SM	27
EZL-B-165	18
EZL-BL-165	18
EZL-DB-165	18
EZL-M-165	18
EZL-TE-165	18

F

C

CAD-TE	33
CB-BUBBLE	55
CB-CUP	55
CB-MEMO	55
CB-OWL	55
CB-POT	55
CB-WHALE	55
CS-OVAL-8	60
CS-RECT-8	60
CS-WALL-100	60

E

ELE-B-LA	27
ELE-BL-LA	27
ELE-BL-ME	27
ELE-BL-SM	27
ELE-B-ME	27

FB-BEAR	51
FB-BOTTLE	51
FB-BUBBLE	51
FB-BUTTERFLY	51
FB-CAR	51
FB-CAT	51
FB-CB-HEX	54
FB-CHICKEN	51
FB-CLOCK	53
FB-CLOUD	51
FB-CUP	51
FB-DINO	51
FB-DOLPHIN	51
FB-FISH	51
FB-FLAG	61
FB-FLOWER	51
FB-GLASS	51
FB-HEART	51
FB-HORSE	51
FB-MOKA	50
FB-OVAL	51
FB-PLAN	53
FBS-ARROW	38
FB-SM4	50
FB-SQUARE	51
FBS-RECTANGLE	38
FB-STARS	51
FBTA-A4	25
FBTA-BEER	24
FBTA-BURGER	24

FBTA-CHAMPAIGN	24
FBTA-CHEF	24
FBTA-COCKTAIL	24
FBTA-CUP	24
FBTA-ICECREAM	24
FBTA-MENU	24
FBTA-PIZZA	24
FBTA-PLATE	24
FBTA-SANDWICH	24
FBTA-WINE	24
FBT-CARRY	22
FBT-CUP	23
FBT-CUP-3	23
FBT-HOUSE	23
FBT-MEMO	23
FBT-MIX-3	23
FBT-PLATE	23
FBT-PLATE-3	23
FBT-TEAPOT	23
FBT-TEAPOT-3	23
FB-WIFI	50

J

JUN-M-A4	29
----------	----

L

LB-DB-62	62
LES-BL-100	57
LES-TE-100	57
LP-BL-1	19
LP-BL-1	125
LP-BL-1	127
LP-BL-2	19
LS-BAR	109
LS-OPEN	109
LS-PIZZA	109
LW-GY-58	52
LW-GY-78	52

M

MC3-CYA4-BR1	97
MC3-CYA4-BR2	97
MC3-CYA4-BR3	97
MC-BOX-BRA4-BL	93
MC-BOX-BRA4-WR	93

MC-BOX-CRA4-BL	84
MC-BOX-CRA4-BR	84
MC-BOX-CRA4-WR	84
MC-BOX-DRA4-CORK	98
MC-BOX-DRA4-PAISLEY	98
MC-BOX-DRWC-CORK	98
MC-BOX-TRA4-BL	87
MC-BOX-TRA4-BU	87
MC-BOX-TRA4-GR	87
MC-BOX-TRA4-LB	87
MC-BOX-TRA4-WR	87
MC-BOX-WRA4-BL	91
MC-BOX-WRA4-BR	91
MC-BOX-WRA4-WR	91
MC-BRA4-BL	92
MC-BRA4-WR	93
MC-BRA5-BL	92
MC-BRA5-WR	93
MC-BRBP-BL	92
MC-BRWC-BL	92
MC-CBA4-BR	95
MC-CBBP-BR	95
MC-CR45-BL	85
MC-CR45-WR	85
MC-CRA4-BI	84
MC-CRA4-BL	84
MC-CRA4-BR	84
MC-CRA4-WR	84
MC-CRA5-BI	84
MC-CRA5-BL	84
MC-CRA5-BR	84
MC-CRA5-WR	84
MC-CRBP-BL	85
MC-CRWC-BL	85
MC-DBBP-BL	83
MC-DBBP-BL	87
MC-DBBP-GY	83
MC-DR45-CROC	99
MC-DRA4-CORK	98
MC-DRA4-CROC	99
MC-DRA4-DUNE	98
MC-DRA4-PAISLEY	98
MC-DRA4-VELVET	99
MC-DRA4-WOOD	98
MC-DRWC-CORK	98
MC-DRWC-VELVET	99
MC-LD45-BL	101
MC-LD45-CP	101
MC-LD45-SL	101
MC-LDA4-BL	101
MC-LDA4-CP	101

MC-LDA4-SL	101
MC-LD-MC10	101
MC-LDSP-BL	101
MC-LDSP-CP	101
MC-LDSP-SL	101
MC-LIA4-IJ	101
MC-LIA4-LJ	101
MC-LRA4-EGBL	80
MC-LRA4-EGRE	80
MC-LRA4-ROBL	81
MC-LRA4-ROBR	81
MC-LRA4-ROWT	81
MC-LRA4-RWBL	80
MC-LRPM-ROBL	81
MC-MGA4-BL	96
MC-MGA4-BR	96
MC-RCA4-BL	89
MC-RCA4-BL-FK	89
MC-RCA4-BU	89
MC-RCA4-BU-FK	89
MC-RCA4-GR	89
MC-RCA4-GR-FK	89
MC-RCA4-OR	89
MC-RCA4-OR-FK	89
MC-RCA4-RD	89
MC-RCA4-RD-FK	89
MC-RCA4-VT	89
MC-RCA4-WT	89
MC-RCA4-WT-FK	89
MC-RCWC-BL	89
MCS-115-TE	125
MCS-2A4-PA	123
MCS-3A4-CS	115
MCS-4A4-BL-SET	119
MCS-4A4-LSS	113
MCS-4A4-OAK	127
MCS-4A4-WAL	127
MCS-4A4-WALDB	116
MCS-4A4-WLR	121
MCS-4A4-WLR-SET	121
MCS-4A4-WLSS	116
MCS-4A4-WLTE	116
MCS-6A4-CS	115
MCS-6A4-LSS	113
MCS-A4-OAK	127
MCS-A4-WAL	127
MCS-BA-120-G1	113
MCS-BA-125-SET	116, 127
MCS-BA-135-E3	115, 123
MCS-BA-85-SET	127

MCS-BA-95-E2	115, 123
MCS-BA-E1	115, 123
MCS-BA-G2	113
MCS-BATT	19, 62, 113, 115, 116, 119, 121, 125, 127
MCS-WH-2	113, 115, 116, 119, 121, 123, 125, 127
MC-TI45	85, 87, 99
MC-TIA4	81, 85, 87, 88, 99
MC-TIA5	85, 87
MC-TR45-BL	87
MC-TR45-LB	87
MC-TR45-WR	87
MC-TRA4-BL	87
MC-TRA4-BU	87
MC-TRA4-GR	87
MC-TRA4-LB	87
MC-TRA4-WR	87
MC-TRA4-WT	99
MC-TRA5-BL	87
MC-TRA5-BU	87
MC-TRA5-GR	87
MC-TRA5-LB	87
MC-TRA5-WR	87
MC-TRBC-WT	99
MC-TRBP-BL	87
MC-TRWC-BL	87
MC-WIA4-BI	91
MC-WIA4-BL	91
MC-WIA4-BR	91
MC-WIA4-BU	91
MC-WIA4-GR	91
MC-WIA4-WR	91
MC-WIA5-BI	91
MC-WIA5-BL	91
MC-WIA5-BR	91
MC-WIA5-BU	91
MC-WIA5-GR	91
MC-WIA5-WR	91
MC-WRA4-BI	91
MC-WRA4-BL	91
MC-WRA4-BR	91
MC-WRA4-BU	91
MC-WRA4-GR	91
MC-WRA4-WR	91
MC-WRA5-BI	91
MC-WRA5-BL	91
MC-WRA5-BR	91
MC-WRA5-BU	91
MC-WRA5-GR	91
MC-WRA5-WR	91

MNI-B-KR	28
MNI-B-KR-1	28
MNI-BL-KR	28
MNI-BL-KR-1	28
MNI-M-KR	28
MNI-M-KR-1	28

P

PFT-ACL-A4	107
PFT-ACL-A5	107
PFT-ACL-A6	107
PFT-ACV-A4	107
PFT-ACV-A5	107
PFT-ACV-A6	107
PFT-ACY-A5	107
PFT-ACY-A6	107
PFT-BL-LA	107
PFT-BL-ME	107
PFT-BL-SM	107
PFT-TE-LA	107
PFT-TE-ME	107
PFT-TE-SM	107
PFW-27-36-BL	104
PFW-A3-BL	105
PFW-A3-GY	105
PFW-A3-RD	105
PFW-A3-YE	105
PFW-A4-BL	105
PFW-A4-GY	105
PFW-A4-RD	105
PFW-A4-YE	105
PNT-BL-LA	58
PNT-BL-SM	58
PNT-GY-LA	58
PNT-GY-SM	58

R

RS-200-BL	133
RS-200-RD	133
RS-CL-CH-B1	130
RS-CL-CH-B2	130
RS-CL-CH-SET	130
RS-CL-GO-A1	130
RS-CL-GO-A2	130
RS-CL-GO-SET	130
RS-CLRP-CHBL	132
RS-CLRP-CHBR	132

RS-CLRP-CHBU	132
RS-CLRP-CHRD	132
RS-CLRP-CHWT	132
RS-CLRP-GOBL	132
RS-CLRP-GOBR	132
RS-CLRP-GOBU	132
RS-CLRP-GORD	132
RS-CLRP-GOWT	132
RS-CLWH-CH	133
RS-CLWH-GO	133
RS-LW-CH	131
RS-RT-BL-C8	134
RS-RT-BL-C9	134
RS-RT-LW-CH	135
RS-RT-RVS-BL-C4	134
RS-RT-RVS-BL-SET	134
RS-RT-RVS-BU-C5	134
RS-RT-RVS-C3	134
RS-RT-RVS-GY-C2	134
RS-RT-RVS-GY-SET	134
RS-RT-RVS-RD-C1	134
RS-RT-RVS-RD-SET	134
RS-RTWM-RVS-GY	134
RS-RTWM-RVS-RD	134
RS-SIGN-A4-PC	132
RS-SIGN-A4-PG	132
RS-SIGN-A4-PS	134
RST-DB-40	31
RST-DB-60	31

S

SBD-B-85	11
SBD-BL-85	13
SBD-DB-85	11
SBD-M-85	11
SBD-TE-85	11
SBDW-TE-85	13
SBM-BL-115	14
SBM-FEET	14
SBM-SS-115	14
SBM-WT-115	14
SBS-B-135	11
SBS-BL-120	13
SBS-B-MNI	29
SBS-DB-120	11
SBS-M-135	11
SBS-TE-120	11
SBSW-M-120	13
SBSW-TE-120	13

Index

SDT-B-120 11
 SDT-M-120..... 11
 SECCLEAN-GR 73
 SECCLEAN-KL 73
 SECSTN-5 73
 SI-SS-SET 108
 SMA100-BL 67
 SMA100-BU 67
 SMA100-GR 67
 SMA100-OR 67
 SMA100-PI 67
 SMA100-RD 67
 SMA100-VT 67
 SMA100-WT 67
 SMA100-YE 67
 SMA200-WT 77
 SMA510-BL 67
 SMA510-BU 67
 SMA510-GD 67
 SMA510-GR 67
 SMA510-OR 67
 SMA510-PI 67
 SMA510-RD 67
 SMA510-SL 67
 SMA510-V4 69
 SMA510-V4-WT 69
 SMA510-V8 69
 SMA510-V8-ET 69
 SMA510-V8-WT 69
 SMA510-VT 67
 SMA510-WT 67
 SMA510-YE 67
 SMA610-V2-WT 72
 SMA610-V4 72
 SMA610-V4-BW 72
 SMA610-V4-WT 72
 SMA720-BU 67
 SMA720-GR 67
 SMA720-OR 67
 SMA720-PI 67
 SMA720-RD 67
 SMA720-V4 69
 SMA720-V4-WT 69
 SMA720-V8 69
 SMA720-V8-ET 69
 SMA720-V8-WT 69
 SMA720-VT 67
 SMA720-WT 67
 SMA720-YE 67
 SMA820-V2-WT 72
 SMA820-V4 72

SMA820-V4-BW 72
 SMA820-V4-WT 72
 SP-BL-SM-F1 136
 SP-BL-SM-F2 136
 SPONGE-2 73
 SP-SS-SM-F1 136
 SP-SS-SM-F2 136
 SP-SS-WM2 136
 STN-SS-CO 40

T

TAG-A4-WT 36
 TAG-A5-WT 36
 TAG-A6-BL 36
 TAG-A6-WT 36
 TAG-A7-BL 36
 TAG-A7-WT 36
 TAG-A8-BL 36
 TAG-A8-WT 36
 TAG-BO-WT 35
 TAG-BUBBLE-5 38
 TAG-BUTTERFLY-5 38
 TAG-FLOWER-5 38
 TAG-HLD-AC 37
 TAG-HLD-BL 37
 TAG-HLD-CP 37
 TAG-HLD-TE 37
 TAG-HLD-TR 37
 TAG-RECTANGLE-5 38
 TAG-SBS-WT 39
 TAG-VELCRO 37
 TBA-BL-A5 35
 TBA-BL-A6 35
 TBA-BL-A7 35
 TBA-BL-A8 35
 TN-1-10-WT 39
 TN-11-20-WT 39
 TN-21-30-WT 39
 TN-31-40-WT 39
 TN-41-50-WT 39
 TN-51-60-WT 39
 TN-RES-DE-WT 39
 TN-RES-EN-WT 39
 TN-RES-ES-WT 39
 TN-RES-FR-WT 39
 TN-RES-IT-WT 39
 TN-RES-NL-WT 39
 TT-DB-LA 27
 TT-DB-XL 27

W

WBC-G-105 47
 WBC-G-85 47
 WBL-DB-100 46
 WBL-DB-120 46
 WBL-DB-150 46
 WBL-TE-100 46
 WBL-TE-120 46
 WBL-TE-150 46
 WBU-B-40 45
 WBU-B-60 45
 WBU-B-70 45
 WBU-BL-40 45
 WBU-BL-60 45
 WBU-BL-70 45
 WBU-DB-30 46
 WBU-DB-40 46
 WBU-DB-50 46
 WBU-DB-60 46
 WBU-DB-70 46
 WBU-M-40 45
 WBU-M-50 45
 WBU-M-60 45
 WBU-M-70 45
 WBU-M-80 45
 WBU-TE-40 46
 WBU-TE-50 46
 WBU-TE-60 46
 WBU-TE-70 46
 WBW-BL-20-24 49
 WBW-BL-20-40 49
 WBW-BL-30-40 49
 WBW-BL-40-60 49
 WBW-BL-60-80 49
 WB-WR-1 30
 WB-WR-3 30
 WBW-TE-20-24 49
 WBW-TE-20-40 49
 WBW-TE-30-40 49
 WBW-TE-40-60 49
 WBW-TE-60-80 49
 WD-3A2-ES 75
 WD-3A2-FD 75
 WD-3A2-HL 75
 WD-3A2-LN 75
 WD-3A2-SG 75
 WD-3A2-SP 75
 WD-3A2-XM 75
 WD-3A3-PL 75

marker
 your
 business

Use
 Securit®





Securit®

D DISPLAYS

your
INFORMATION

CATALOG 2017 | V1

WWW.SECURIT.NL

VERMES BV
KATERNSTRAAT 1
1321 NC ALMERE THE NETHERLANDS +31 (0)36 531 3554
INFO@VERMES.NL